



# IEEE Nanotechnology Council Newsletter, October - 2017



## Editor's Note

I am delighted to bring you this quarter's newsletter. In this issue, you can see there is very strong evidence emerging that IEEE NTC's activities are extremely successful together with the fact that we have formed a IEEE NTC group in the social media with more than 4000 established and young researchers to connect and communicate the current happenings in the nanotechnology. I hope you enjoy this issue and do let us know if there is any topic you'd like to see covered in the future issue.

**Jr-Hau He**

Associate Professor  
King Abdullah University of Science and Technology  
EiC Newsletter & Web Content

## President's Note

**Dear IEEE Nanotechnology Council Community,**

Welcome to the IEEE Nanotechnology Council (NTC) which is one of the seven councils of the IEEE! On behalf of our 7,000+-membered community, it is my pleasure to welcome you to the IEEE-NTC. The Council is a multi-disciplinary group of professional engineers and scientists supporting the theory, design, and development of nanotechnology and its scientific, engineering, and industrial applications and with the purpose of promoting and guiding state-of-the-art research in the field of nanotechnology.

I am very proud to announce that on February 18, 2018, the IEEE-NTC will celebrate its 16th anniversary. For more than a decade, our mission of advancing nanotech for humanity has never wavered. The members who brought the IEEE-NTC into existence 16 years ago had a desire to impact humanity with the most advanced technologies and ingenuity. Today, the IEEE-NTC has dramatically evolved, along with other IEEE societies, thanks to the current and past elected members and office bearers whose dedication made it happen.

IEEE-NTC is currently made up of 21 IEEE member societies, and I am ecstatic the way young engineering and scientific talents received the council across globe. Our chapter now has many chapters world-wide, including from countries and regions such as Australia, China, Italy, Korea, Singapore, Saudi Arabia, India, Brazil, Taiwan, and needless to say, the United States of America. I invite you all to explore the IEEE-NTC website (<http://sites.ieee.org/nanotech/>) to learn more about how we nurture young science and technology talents. I also encourage you to visit our official IEEE Nanotechnology - Facebook page (<https://www.facebook.com/groups/550239578466583/>). This Facebook group is very active and dedicated platform with more than 4,000 established and young researchers all over the world that helps us to connect and communicate the most current developments in nanoscience and nanotechnology. I would also like to take this opportunity to strongly encourage the group members to actively take part in promoting research and development results, in addition to other valuable information such as conference details and science/engineering related jobs. Our council is already very privileged to have global professionals from many technological and scientific sectors involved in organizing and producing NTC sponsored conferences and publications. I list below the current key NTC sponsored conferences and publications, and do hope that as "Nanotechnology" becomes more matured and widely

accepted into many manufacturing sectors, our global network of professionals will continue to establish new conferences and publications to reflect the state-of-the-art research and development activities related to this extremely important technological revolution for mankind.

### NTC sponsored/co-sponsored publications

IEEE Transactions on Nanotechnology  
IEEE Transactions on NanoBioscience  
IEEE Nanotechnology Magazine  
*IEEE Transactions on Molecular, Biological, and Multi-Scale Communications*  
*IEEE Transactions on Multi-Scale Computing Systems*  
[IEEE Journal on Exploratory Solid State Computational Devices and Circuits](#)

NTC sponsored/co-sponsored conferences  
IEEE International Conference on Nanotechnology (IEEE-NANO)  
IEEE Nanotechnology Materials and Devices Conference (IEEE-NMDC)  
IEEE International Conference on Nano/Micro Engineered and Molecular Systems (IEEE-NEMS)  
IEEE International Conference on Nano/Molecular Medicine and Engineering (IEEE-NANOMED)  
IEEE International Conference on Manipulation, Manufacturing and Measurement on the Nanoscale (IEEE 3M-NANO)

Through these Council's sponsored activities, participants have the opportunity to collaborate and network with colleagues world-wide, stayed informed on developing news, events, standards, and educational activities related to Nanotechnology.

Finally, I must stress that only IEEE members or Society-appointed affiliates may participate in the decision-making process of Nanotechnology Council. If you are not already an IEEE member, consider joining one or more of the IEEE societies which sponsor the Nanotechnology Council. A complete list of sponsoring societies can be found in the box on the right, under the link, "View list of sponsoring societies."



I wish you all a very happy and safe coming holiday season and the best of luck in the rest of 2017!

Wen J. Li  
President,  
IEEE Nanotechnology Council

## Inside this issue:

President's Note	1
IEEE elected Officers	2
IEEE NTC - Awards Ceremony 2017	2
Nobel Prize News	5
Conferences	6
Research Highlights	9
Announcements	11

## Special points of interest:

- IEEE NTC Elected Officers - 2018
- TNANO IMPACT FACTOR
- IEEE NANO 2018
- 13th Annual IEEE International Conference on Nano/Micro Engineered and Molecular Systems
- Successfully conducted the IEEE Summer School on "Nanoelectronic technologies and devices" Toulouse, France, 2017.
- Perovskite solar cells reach record long-term stability, efficiency over 20 percent
- world's first two-dimensional microprocessor

## IEEE NTC Elected Officers - 2018



**The IEEE Nanotechnology Council (NTC) elected new officers at its Annual Meeting held July 25 in Pittsburgh in conjunction with its 2017 International Conference on Nanotechnology (IEEE NANO).**

Representatives of the twenty-two IEEE Societies who are



Council members gather annually to conduct Council business and elect officers. This year two positions were up for election: Vice-President for Technical Activities 2018-19 and Vice-President for Publications for 2018-19.

Michel Frechette of the Hydro-Québec (Canada) Research

Institute (IREQ) and Associate Professor at École de technologie Supérieure (ETS) in Montreal was elected as Vice-President for Technical Activities.

Frechette has been active in research for the last 40 years, practicing an applied basic approach at IREQ and collaborating with various international bodies and universities. For numerous years, he has been an Associate Professor at École de technologie Supérieure (ETS) in Montreal. For the past 10 years, his major scientific contributions were to the field of nanodielectrics and high-voltage applications.

Prof. Jin-Woo Kim, Director of the Bio/Nano Technology Group in the Institute for Nanoscience & Engineering at the University of Arkansas, USA was elected as Vice-President for Publications.

Kim is past editor-in-chief of ENANO and is a long time member of the Conference Steering Committee for the IEEE International Conference on Nano/Molecular Medicine and Engineering (IEEE-NANOMED).

Both positions are effective as of January 1, 2018.

## Awards Ceremony - 2017

**The IEEE Nanotechnology Council 2017 Awards Ceremony was held in conjunction with the IEEE NANO 2017 banquet in Pittsburgh, Pennsylvania (USA) on July 27, 2017.**



The Pioneer Award in Nanotechnology recipient was Paras N. Prasad, Distinguished Professor of Chemistry, Physics, Medicine and Electrical Engineering, at the University at Buffalo (NY). The Early Career Award in Nanotechnology recipient was Professor Duygu Kuzum of the Jacobs School of Engineering at the University of California, San Diego. The Distinguished Service Award recipient was Dominic Massetti of OmniVision Technologies, Inc., Seal Beach, CA.

IEEE Nanotechnology Council Pioneer Award in Nanotechnology

The Pioneer Award in Nanotechnology is to recognize individuals who by virtue of initiating new areas of research, development or engineering have had a significant impact on the field of nanotechnology. The award is intended for people who are in the mid or late portions of their careers, i.e., at least 10 years beyond his or her highest earned academic degree on the nomination deadline date.

The 2017 recipient of the IEEE NTC Pioneer Award in Nanotechnology is Paras N. Prasad, a Professor at the State University of New York (SUNY), Buffalo. His award citation states: "For pioneering contributions in creating multifunctional nanoprobe, applying

nanophotonics in biomedical technology, and educating future researchers"

Professor Prasad is known for his groundbreaking research on optically-tracked nonviral nanoprobe gene delivery. He has also demonstrated nanoprobe for manipulation of optical interactions, controlling light propagation, and redirecting energy flow at the nanoscale for applications in biology and medicine. He is also known for developing "Nanoclinic" multimodal nanoparticle platforms for diagnosing and targeted treatment of diseases.

Prasad is a Distinguished Professor of Chemistry, Physics, Medicine and Electrical Engineering, the highest rank in the New York State University system. He also holds the Samuel P. Capen Chair at the University at Buffalo and is the Executive Director of the multidisciplinary Institute for Lasers, Photonics and Biophotonics. Dr. Prasad has published over 700 scientific papers, co-edited six books, and co-authored a monograph (with D.J. Williams), "Introduction to Nonlinear Optical Effects in Molecules and Polymers." Dr. Prasad published "Introduction to Biophotonics," the first monograph in this field, which authoritatively defines the field, details its scope and identifies emerging opportunities. He has also published monographs, "Nanophotonics," which includes its impact on Nanomedicine and "Introduction to Nanomedicine and Nanobioengineering". Dr. Prasad also holds a number of patents.



Dr. Prasad has received much recognition for his pioneering contributions. He received Scientific American's Top 50 (2005), Fellow of SPIE (2005), 2003 & 2008 Inventor of the Year in Life Sciences Award by the Technical Council of the Niagara Frontier (2004,2009). He is a Fellow of

the American Physical Society and a Fellow of the Optical Society of America. He is also a recipient of the prestigious Sloan and Guggenheim fellowships. Dr. Prasad has received the Schoellkopf Award of the Western New York American Chemical Society for his academic achievements. He was also awarded the Technology/Discovery award from the Western New York Health Care Industries Association for his pioneering work on "Nanoclinics" for Biophotonics. He has been awarded by the Chancellor of the State University of New York system the "Excellence in Pursuit of Knowledge" award. He was a recipient of the Morley Prize of the Cleveland Section of the American Chemical Society. He has received a honorary professorship from Zhejiang University in China for his pioneering work in photonics, nanophotonics and biophotonics, as well as for his world leadership advancing a global infrastructure in science and technology. Recently he received an honorary doctorate from the Royal Institute of Technology in Sweden (KTH) for his pioneering work in areas including the use of light-based technologies to address important, global health problems. Aix-Marseille University (AMU) in France has recently awarded Dr. Prasad with a Honorary Degree. Publishing of his book "Introduction to Nanomedicine and Nanobioengineering" was recently recognized by the University at Buffalo in the Sixth Salute to UB Authors.

Dr. Prasad has also been a leader in promoting international scientific infrastructures. He organized six "International Conferences on Frontiers of Polymers and Advanced Materials" (India, 1991; Indonesia, 1993; Malaysia, 1995; Egypt, 1997; Poland, 1999; Brazil, 2001). Each of these conferences brought together top level scientists, engineers and government representatives from more than 20 countries to develop a global infrastructure for advanced materials and emerging technologies.

Web: <http://www.photonics.buffalo.edu/index.html>

#### IEEE Nanotechnology Council Early Career Award in Nanotechnology

The Early Career Award in Nanotechnology is to recognize individuals who have made contributions with major impact on the field of nanotechnology. Up to two awards may be given per year. There may be one award for academics (persons employed by colleges or universities) and one for persons employed by industry or government organizations.

The 2017 recipient of the IEEE NTC Early Career Award in Nanotechnology is Duygu Kuzum at the University of California, San Diego. Her award citation states: "For pioneering contributions towards the development of nanoelectronic synaptic devices for neuromorphic computing."



Professor Kuzum has done path breaking work on nanoelectronic synaptic devices, demonstrating for the first time that a phase change nanoelectronic synapse can be programmed to emulate synaptic learning in the brain. She also invented transparent graphene electrodes for mapping brain activity with high resolution. More recently, she has been developing nanoelectronic synaptic devices with new functionalities being used to create energy efficient and scalable machine learning hardware.

Kuzum received her Ph.D. in electrical engineering from Stanford University in 2010, followed by a postdoctoral fellowship in bioengineering at University of Pennsylvania from 2011 to 2015. In 2004, she received her B.S. in electrical engineering from Bilkent University in Ankara, Turkey. She is the author or co-author of over 40 journal and conference papers. Her work on nanoelectronic devices was featured on the cover of Nano Letters, highlighted in Nature and covered by several media outlets (New Scientist, Stanford News Report, Nanowerk, EE Times). She was a recipient of various awards including a Texas Instruments Fellowship and Intel Foundation Fellowship, PopTech Science and Public Leaders Fellowship Award in 2013 and Penn Neuroscience Pilot Innovative Research Award in 2014. She was also named among the Innovators Under 35 (TR35) by MIT Technology Review in 2014.

Web Page: <http://neuroelectronics.ucsd.edu/>

#### IEEE Nanotechnology Council Distinguished Service Award:



The Distinguished Service Award recognizes an individual who has performed outstanding service for the benefit and advancement of the IEEE Nanotechnology Council.

The 2017 recipient of the IEEE NTC Distinguished Service Award is Dominic Massetti of OmniVision

Technologies, Inc., Seal Beach, Calif. His award citation states: "Exemplary service to the IEEE San Francisco Bay Area Nanotechnology Council Chapter by organizing and facilitating educational and networking events."

Mr. Massetti played the key role in forming the IEEE San Francisco Bay Area Nanotechnology Council Chapter, and has served as its President in 2009 and 2014. He has helped with all aspects of the organization and promotion of 12 monthly seminars and events for the past 10 years. He has obtained corporate sponsorship for these events and he has made extraordinary efforts to create nanotechnology awareness among students. He has also devised meetings where job seeking engineers speak to an audience of hiring technical managers and recruiters.

Massetti has over 30 years of industry experience spanning multiple applications of Integrated Circuit device and fabrication technology. Most recently he directed technology related assessments of intellectual property for IPValue Management. He mined and evaluated the patent portfolios of Fortune 500 high-tech companies. He previously served as Senior Director, VLSI Manufacturing Technology, for HDD industry leader Seagate Technology where he ensured mass market commercialization of state-of-the-art IC fabrication technology.

Prior to that, he was Director of Technology Development & Quality Systems at Texas Instruments. There he developed and applied high speed analog BiCMOS manufacturing technologies to products used in high capacity storage systems, wireless communication components, and PC processor interfaces. Earlier in his career he developed CMOS logic and non-volatile memory technologies, and managed pilot fabrication lines at NCR Microelectronics and Philips Semiconductors.

He has been active in promoting nanotechnology by organizing fo-





runs and speaking on the subject. He has published related on-line articles for NanoInvestor News. As an NSF peer reviewer he continues to support investments in small high tech businesses.

Mr. Massetti holds a Master of Science degree in Applied Solid State Physics from the University of California, San Diego. He also earned his Bachelor of Science degree in Physics.

#### TNANO Best Paper 2016 Award:



At the beginning of each year, T-NANO selects a paper that appeared in the Transactions during the previous calendar year for its Best Paper Award. Candidate papers are nominated by members of the Editorial Board. Evaluation is done by members of the Senior Editors Panel, with criteria including

technical merit, originality, potential impact on the field, clarity of presentation, and practical significance for applications.

The TNANO Best Paper Award for 2016 is “Wave-Based Neuromorphic Computing Framework for Brain-Like Energy Efficiency and Integration”, written by Yasunao Katayama, Toshiyuki Yamane, Daiju Nakano, Ryosho Nakane, and Gouhei Tanaka.

Yasunao Katayama received B.S. and M.S. degrees in physics from Tokyo University, Tokyo, Japan, in 1984 and 1986, respectively, and a Ph.D. in electrical engineering from Princeton University, Princeton, NJ, in 1994. He is currently with IBM Research – Tokyo, Tokyo, Japan. He has been involved with a variety of academic disciplines covering physics, information theory, and semiconductor/optical communication research. More specifically, he has been working on positron physics, fractional quantum Hall effect, quantum devices, numerical analysis, memory technology and systems, logic/DRAM integration, information theory, wireless and optical communication systems, and more recently on a new computing paradigm including neuromorphic computing.

Toshiyuki Yamane received B.S., M.S., and Ph.D. degrees in mathematical engineering and information physics from Tokyo University in 1995, 1997, and 2000. He joined IBM research – Tokyo in 2000. Since then, he has been working on a variety of projects related to mathematical engineering based on statistics and signal processing. His major research interests include error corrections, wireless communications, and design methodology and performance analysis of the conventional and future bio-inspired computing systems. He is a member of the IEEE Communications Society.

Daiju Nakano received B.S. and M.S. degrees in physics from the University of Tokyo in 1994 and 1996. He joined IBM in 1996 and is currently a researcher with IBM Research, Tokyo Research Laboratory. His major field is optical physics related to laser spectroscopy and at IBM he has been involved with liquid crystal display technology, TFT-array tester development and wireless communication research. He is currently engaged in research on neuromorphic science and engineering, more specifically on designing hardware architecture for neuromorphic computing.

Ryosho Nakane received B.S. and M.S. degrees in electronics engineering from Hokkaido University, Sapporo, Japan, in 2000 and 2002, and a Ph. D. in electronics engineering from the University of Tokyo, Tokyo, Japan, in 2005. Since October 2013, he has been a Project Research Associate Professor at the University of Tokyo. His current research interests include semiconductor-based spintronic devices, semiconductor-based electronic devices for next-generation integrated circuits, and neuromorphic electronic devices for energy-efficient systems. He is a member of the IEEE Electron Device Society and the Japan Society of Applied Physics.

Gouhei Tanaka received a B.E. degree in mathematical engineering and a Ph.D. in complexity science from the University of Tokyo, Tokyo, Japan, in 2000 and 2005, respectively. Currently, he is a Project Associate Professor at the Graduate School of Engineering, the University of Tokyo. His research interests include mathematical modeling of nonlinear dynamical phenomena and its application to biological, technological, and engineering systems.

**Congratulation to all the IEEE NTC Awardees of 2017!!**



**IEEE Transactions on Nanotechnology - TNANO - 2016 IMPACT FACTOR - 2.485\***

**IEEE Transactions on Nanotechnology (TNANO)** is pleased to announce a new 2016 impact factor (IF) of 2.485\*! This represents 46% increase from the 2015 IF, upholding the TNANO's status as one of the leading peer-reviewed journals in the field of nanotechnology. The official journal of IEEE Nanotechnology Council (NTC), TNANO publishes a collection of peer-reviewed articles and short reports (i.e., letters) of original research and perspectives and reviews and mini-reviews on emerging topics. TNANO offers rapid peer-review and can publish an accepted article online through IEEE Xplore as soon as it is submitted in final form. Web-published papers have DOI (Digital Object Identifier), and are fully citable and downloadable. Make sure your manuscript has the impact and gets the attention it deserves by submitting your article to TNANO today.

\*2016 Journal Citation Reports published by Clarivate Analytics, 2017.

## Nobel Awards in Science - 2017

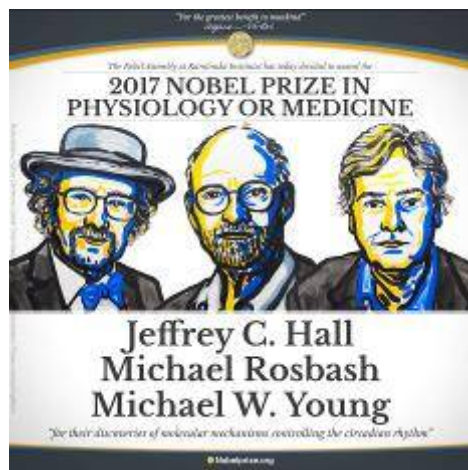

### MEDICINE:

The Nobel Assembly at Karolinska Institutet has today decided to award the 2017 Nobel Prize in Physiology or Medicine jointly to Jeffrey C. Hall, Michael Rosbash and Michael W. Young

“for their discoveries of molecular mechanisms controlling the circadian rhythm”.

Life on Earth is adapted to the rotation of our planet. For many years we have known that living organisms, including humans, have an internal, biological clock that helps them anticipate and adapt to the regular rhythm of the day. But how does this clock actually work? Jeffrey C. Hall, Michael Rosbash and Michael W. Young were able to peek inside our biological clock and elucidate its inner workings. Their discoveries explain how plants, animals and humans adapt their biological rhythm so that it is synchronized with the Earth's revolutions.

Press release: [goo.gl/i7LWaK](http://goo.gl/i7LWaK)

Advanced information (pdf): [goo.gl/UVTmx3](http://goo.gl/UVTmx3)

### PHYSICS:

The Royal Swedish Academy of Sciences has decided to award the Nobel Prize in Physics 2017

with one half to Rainer Weiss and the other half jointly to Barry C. Barish and Kip S. Thorne at LIGO/VIRGO COLLABORATION LIGO Scientific Collaboration “for decisive contributions to the LIGO detector and the observation of gravitational waves”.

On 14 September 2015, the universe's gravi-

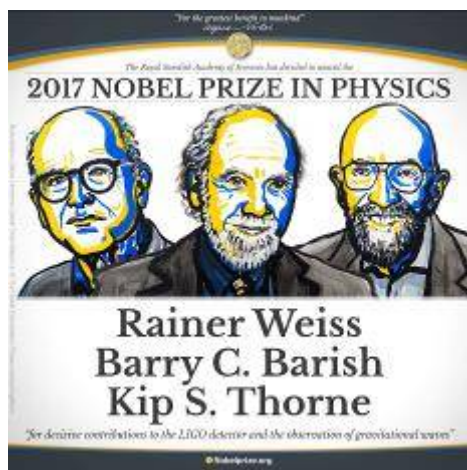

tational waves were observed for the very first time. The waves, which were predicted by Albert Einstein a hundred years ago, came from a collision between two black holes. It took 1.3 billion years for the waves to arrive at the LIGO detector in the USA.

The signal was extremely weak when it reached Earth, but is already promising a revolution in astrophysics. Gravitational waves are an entirely new way of observing the most violent events in space and testing the limits of our knowledge.

LIGO, the Laser Interferometer Gravitational-Wave Observatory, is a collaborative project with over one thousand researchers from more than twenty countries. Together, they have realised a vision that is almost fifty years old. The 2017 Nobel Laureates have, with their enthusiasm and determination, each been invaluable to the success of LIGO. Pioneers Rainer Weiss and Kip S. Thorne, together with Barry C. Barish, the scientist and leader who brought the project to completion, ensured that four decades of effort led to gravitational waves finally being observed.

Press release: [goo.gl/7auu](http://goo.gl/7auu)

Popular information "Cosmic chirps" (pdf): [goo.gl/VaR6qp](http://goo.gl/VaR6qp)

Advanced information by the Nobel Committee for Physics (pdf): [goo.gl/7avfu5](http://goo.gl/7avfu5)

### CHEMISTRY:

The Royal Swedish Academy of Sciences has decided to award the Nobel Prize in Chemistry 2017 to Jacques Dubochet, Joachim Frank and Richard Henderson “for developing cryo-

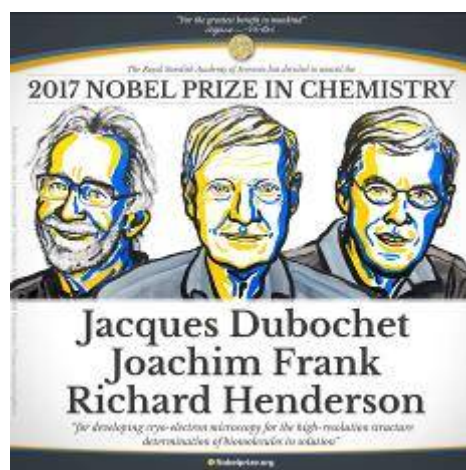

electron microscopy for the high-resolution structure determination of biomolecules in solution.”

This cool microscope technology has revolutionised biochemistry.

We may soon have detailed images of life's complex machineries in atomic resolution. The Nobel Prize in Chemistry 2017 is awarded to Jacques Dubochet, Joachim Frank and Richard Henderson for the development of cryo-electron microscopy, which both simplifies and improves the imaging of biomolecules. This method has moved biochemistry into a new era.

A picture is a key to understanding, and scientific breakthroughs often build upon the successful visualisation of objects invisible to the human eye. However, biochemical maps have long been filled with blank spaces because the available technology has had difficulty generating images of much of life's molecular machinery.

Cryo-electron microscopy changes all of this. Researchers can now freeze biomolecules mid-movement and visualise processes they have never previously seen, which is decisive for both the basic understanding of life's chemistry and for the development of pharmaceuticals.

Press release: [goo.gl/ZpPKjm](http://goo.gl/ZpPKjm)

Popular information: [goo.gl/36TUwC](http://goo.gl/36TUwC)

Advanced information: [goo.gl/vBasPu](http://goo.gl/vBasPu)

Source: [nobelprize.org](http://nobelprize.org)

## Conferences



### **IEEE NANO 2018 | Cork, Ireland | 23-26 July 2018**

The 18th IEEE International Conference on Nanotechnology comes to Cork, Ireland from 23 to 26 July 2018. In addition to the traditional IEEE NANO session topics, the thematic focus for this year's event is Nano-Enabled Smart Things, including topics such as: Nanosensors & Nanoactuators

Nanoenergy for Smart Things  
Nanoelectronics (Emerging Research Materials, Devices & Architectures)  
Nanofabrication & Assembly  
Nano Life Sciences  
**Plenary Speakers include:**  
Prof. John A. Rogers, Northwestern University, and  
Prof. Clivia M. Sotomayor Torres, Catalan Institute of Nanoscience and Nanotechnology.

Visit [www.ieeenano18.org](http://www.ieeenano18.org) to register your interest.

#### **Venue:**

Cork, the gourmet capital of Ireland, offers the buzz of a dynamic city coupled with unspoiled landscapes and over a thousand years of culture and history. Cork is also home to Tyndall National Institute, one of Europe's leading research centres in integrated ICT hardware and systems, and host to IEEE NANO 2018. At Tyndall, we specialise in 'atoms to systems' research in both electronics and photonics – from atomistic simulations to advanced materials, devices, circuits and systems. We work

with industry and academia to deliver real impact in our core market areas of communications, energy, health, agri-food and the environment.

#### **Key dates:**

Call for abstracts: 20 November 2017  
Abstract submission deadline: 26 January 2018  
Notification of Acceptance: 16 March 2018  
End of early registration: 25 April 2018  
Deadline for final papers: 11 May 2018

**We look forward to welcoming you to IEEE NANO 2018!**



**The 13th Annual IEEE International Conference on Nano/Micro Engineered and Molecular Systems (IEEE-NEMS)** will be held from 22-26, April 2018 at Grand Hyatt, Singapore.

The IEEE-NEMS is a premier conference series sponsored by the IEEE Nanotechnology Council focusing on the promotion of advanced research areas related to MEMS, nanotechnology, and molecular technology. Prior conferences were held in Los Angeles (USA, 2017), Matsushima Bay and Sendai (Japan, 2016), Xian (China, 2015), Hawaii (USA, 2014), Suzhou (China, 2013), Kyoto (Japan, 2012), Kaohsiung (Taiwan, 2011), Xiamen (China, 2010), Shenzhen

(China, 2009), Hainan Island (China, 2008), Bangkok (Thailand, 2007), and Zhuhai (China, 2006). The IEEE-NEMS Conference typically attracts over 600 attendees with participants from more than 20 countries and regions worldwide.

#### **Conference Scope:**

Nano Energy, Micro Energy Harvesting, Energy Materials  
Micro/Nano Electro-Mechanical Systems (M/NEMS)  
Nanoscale Robotics, Assembly, and Automation  
Flexible/Soft Materials, Sensors and Actuators  
Micro/Nanotechnology in Neural Prostheses  
Molecular Sensors, Actuators, and Systems

Micro/Nano Lens and Nanoscale Imaging  
Micro/Nano/Molecular Fabrication  
Nanophotonics and Microoptics  
Plasmonic and Metamaterials  
Nanobiology/Nanomedicine  
Micro/Nano Mechanics  
Micro/Nano Fluidics  
2D/Nanomaterials

#### **Important Dates:**

2-page abstract submission : Nov. 15, 2017  
Acceptance Notification: Dec 15, 2017  
Final Full Paper Submission: Jan 15, 2018  
Early Bird Registration: Jan 2018

**Submissions:** <http://ieeenems2018.org/>

#### **Plenary Speakers**

Masayoshi Esashi  
Professor, Micro System Integration Center ( $\mu$ SIC), Tohoku University, Japan  
Zhong Lin (ZL) Wang  
Professor, Beijing Institute of Nanoenergy and Nanosystems, Chinese Academy of Sciences,

Beijing, China & School of Materials Science and Engineering, Georgia Institute of Technology, Atlanta, USA

#### **General Chair :**

Prof. Chengkuo Lee  
National University of Singapore

#### **Technical Program Chair:**

Prof. Da-Jeng Yao  
National Tsing Hua University

#### **Steering Committee**

Prof. Ning Xi, Michigan State University, USA (Chair)

Prof. Alice H. X. Zhang, Peking University, China

Prof. Daoheng Sun, Xiamen University, China

Prof. Gwo-Bin Vincent Lee, National Tsing Hua University, Taiwan

Prof. Osamu Tabata, Kyoto University, Japan

Prof. Wen J. Li, City University of Hong Kong, Hong Kong

Prof. William C. Tang, University of California, Irvine, USA

Prof. Shuji Tanaka, Tohoku University, Japan

**We look forward to welcoming you to IEEE NEMS 2018!**





**Successfully conducted the IEEE Summer School on "Nanoelectronic technologies and devices" Toulouse, France, 2017.**

Congratulations on the successful event on the 2017 IEEE Summer School on Nanoelectronics that took place at Laboratoire d'Analyse et d'Architecture des Systems (LAAS-CNRS), Toulouse, France on July 10-14 and organized by IRT Saint Exupery and Laplace Laboratory to promote interdisciplinary understanding of Space, Aeronautical, Defence, Nuclear, Transport, Automotive and Telecommunication Systems based on disruptive Nanotechnologies. Industrial, commercial, and government endeavors are focused on developing and pulling off high performance and low consumption systems based on nanoscale products operating under harsh environment and on disruptive GaN (gallium nitride) & DSM (deep sub-micron) technologies. IRT offered the opportunity of a series of annual event and this Summer School in Toulouse area, supported by IEEE Nanotechnology Council, is specially designed for Ph.D. students, Post-Docs and young engineers in electronic equipment design and manufacturing, academics, military, defense and industry personnel.

Seventeen top-level professors, experts, academics and scientists from the Belgium, Serbia, Singapore, Switzerland, USA, and France, offered 4 days' lectures to about 30 multinational graduate students and postdocs participating in the summer school. The 2017 IEEE Summer School on Nanoelectronics took place at Laboratoire d'Analyse et d'Architecture des Systems (LAAS-CNRS), Toulouse, France on July 10-14 and organized by IRT Saint Exupery and Laplace Laboratory to promote interdisciplinary understanding of Space, Aeronautical, Defence, Nuclear, Transport, Automotive and Telecommunication Systems based on disruptive Nanotechnologies. Industrial, commercial, and government endeavors are focused on developing and pulling off high performance and low consumption systems based on nanoscale products operating under harsh environment and on disruptive GaN (gallium nitride) & DSM (deep sub-micron) technologies.



A glimpse from the Summer School:

The Summer School was chaired by Dr Alain Bensoussan, IEEE Senior Member, IRT Saint Exupery, Toulouse and Dr Kremena Makasheva, IEEE Member, LAPLACE – University Paul Sabatier, Toulouse, France. Dr Marise Bafleur, LAAS-CNRS, Toulouse, France. Picture 3 (right to left): Dr. Kremena Makasheva (Laplace Laboratory), Ariel Sirat (Director IRT Saint Exupery), Prof. Gilbert Casamata (President IRT Saint Exupery), Prof. James E. Morris (Portland State University), Dr. A. Bensoussan (IRT Saint Exupery). (right to left).



A group of 2 Summer Schools met at Cité de l'Espace tour.

## Announcement on IEEE-NANOMED 2017



### IEEE-NANOMED 2017: Confirmed Speakers and Call for Late-News- Abstracts

The 11<sup>th</sup> IEEE Int. Conf. on Nano/Molecular Medicine and Engineering (IEEE-NANOMED 2017) will be held at the **Shenzhen Virtual University Park**, from December 1-4, 2017. IEEE-NANOMED is one of the premier annual events organized by the IEEE Nanotechnology Council, and is the conference where practitioners will see nano/molecular medicine and engineering at work in both their own and related fields, from essential and advanced scientific and engineering research and theory to translational and clinical research.

We are now calling for late-news-abstract submissions, which will be due on October 31, 2017 (PST). Each abstract should be 2 pages, following standard IEEE conference paper format. To submit your abstract, please visit the following site:

<http://www.ieee-nanomed.org/2017/submission-for-review/>

If your abstract is accepted (notification of acceptance will be sent by November 7, 2017), and you wish to submit a full paper (4 to 6 pages) for inclusion in the IEEE Explore Data

base, you will need to submit a final version of your paper by January 31, 2018.

For this year's conference, we have already confirmed 9 Plenary Speakers, 4 keynote speakers, and close to 50 special invited speakers to give present their latest research results related to nano/molecular medicine, bioMEMS, and bio-nanotechnology. The list of confirmed Plenary Speaker is shown below. Please visit the conference website for details related to the conference:

<http://www.ieee-nanomed.org/2017/>

#### Confirmed Plenary Speakers

##### **Larry A. NAGAHARA**

Professor, Whiting School of Eng.  
Johns Hopkins University, USA  
Topic: **Nanotechnologies in Healthcare: Current Challenges and Future Prospects**

##### **Chih-Ming HO**

Distinguished Research Professor, Henry Samueli School of Eng. and Applied Science  
University of California, Los Angeles, USA

Topic: **Small Data or Big Data for Personalized Medicine?**

##### **Yanbin LI**

Tyson Endowed Chair in Biosensing Eng., Dept. of Biological & Agricultural Eng.  
University of Arkansas, Fayetteville, USA

##### **Tony Jun HUANG**

Professor, Dept. of Mechanical Eng. and Materials Science

Duke University, USA

Topic: **Acoustic Tweezers: Manipulating Cells and Other Tiny Objects Using Surface Acoustic Waves**

##### **Mingjun ZHANG**

Professor, Dept. of Biomedical Eng./ Davis Heart and Lung Research Inst./Neurological Inst.

The Ohio State University, USA

Topic: **Biological Intelligence Across Scales and Inspiration for Artificial Intelligence in Robotics**

##### **Vincent Gwo-Bin LEE**

University Chair Professor, Dept. of Power Mechanical Eng. National Tsing Hua University, Taiwan

Topic: **Detection of Bacteria on Microfluidic Systems**

##### **Yu SUN**

Professor (Canada Research Chair in Micro and Nano Eng. Sys/), Dept. of Mechanical and Industrial Eng.

University of Toronto, Canada

Topic: **TBD**

##### **John YEOW**

Professor (Canada Research Chair in Micro/Nano Devices), Dept. of Systems Design Eng. University of Waterloo, Canada

##### **Noo Li JEON**

Professor, School of Mechanical and Aerospace Engineering Seoul National University, Korea

Topic: **TBD**

Hope to see you in Shenzhen, China!

#### **Organizing Committee of IEEE-NANOMED2017**

General Chair: Ning GU, Southeast Univ., China

General Co-Chair: Jin-Woo KIM, Univ. of Arkansas, USA

General Co-Chair: Wen J. LI, City Univ. of Hong Kong, Hong Kong

Organizing Chair: Guanglie ZHANG, Shenzhen Academy of Robotics, China

Program Chair: Lianqing LIU, Shenyang Inst. of Automation, China

Program Co-Chair: In-Kyuu PARK, Chonnam National Univ., South Korea





## Journal Highlights

### [Journal on Exploratory Solid-State Computational Devices](#)

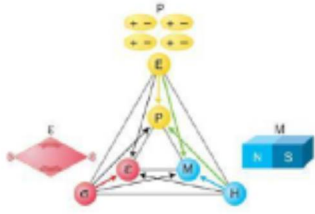

### [and Circuits \(JXCDC\)](#)

JXCDC is an "Open Access" IEEE journal for the publication in multi-disciplinary fields of research towards solid-state circuits using exploratory materials and devices for novel energy efficient computation beyond standard CMOS transistor technology. The papers are selectively chosen to provide an insight into the architectural, circuit and device implications of emerging **Quantum Nano-Electronic or**

**Nano-Magnetic device** technologies.

The papers have a maximum of eight pages in length. Additional supplementary materials expand on the methods, novel metrology and/or design techniques in many cases. The supplementary is intended as a published repository of best practices.

The focus of the publication is on the exploration of **materials, Quantum Nano-Electronic or Nano-Magnetic devices** and **Computation circuits** to enable Moore's Law to continue for computation beyond a 10 to 15 year horizon (beyond end of the roadmap for CMOS technologies) with associated density scaling and improvement in energy efficiency.

**This publication provides a unique interdisciplinary fo-**

**rum of scientists and engineers** to advance this field of promising alternatives to CMOS technology for computation devices, circuits and architecture. This journal had its first paper published in January 2015, and has a number of seminal papers in beyond CMOS.

**2016 papers submitted to the journal took an average of:**

**4.5 weeks** from submission to **First Decision**

**10 weeks** from first submission to Final Decision with Early Publication one week later.

**Citations (as of May 2017) for the papers in the 2015 Issue:**

**Average = 21 (14)** citations per paper by Google Scholar (IEEE Xplore)

**Highest = 74 (42)** citations by Google Scholar (IEEE Xplore)

**Total = 251 (167)** citations Google Scholar (IEEE Xplore)

**Paper Downloads:**

2015 Issue Papers: 6429

2016 Issue Papers: 1104

The JXCDC papers listed order of popularity can be seen online at;

<http://ieeexplore.ieee.org/xpl/topAccessedArticles.jsp?punumber=6570653>

For paper submission details you can go to

<http://mc.manuscriptcentral.com/jxcdc>

Ian Young, Editor-in-Chief, Journal on Exploratory Solid-State Computational Devices and Circuits

## Research Highlights

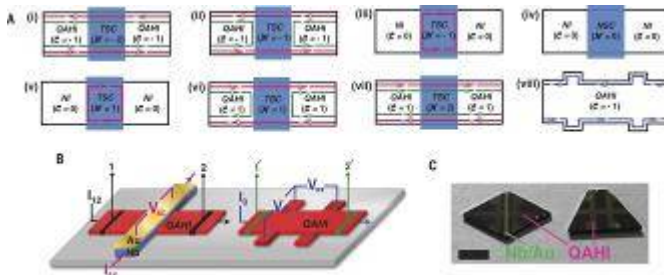

### **Majorana fermion:**

A particle that its own anti-particle has been recently evidenced by researchers lead by Prof. Kang L. Wang, at University of California, Los Angeles. This discovery is believed to conclude the longstanding quest about the existence of Majorana fermions which could be a major breakthrough in the field of quantum computing. Prof. Kang L. Wang is the former Editor of IEEE-Transactions on Nanotechnology. Please join me in congratulating Prof. Kang L. Wang and his team in this occasion for an excellent discovery.

### **Reference:**

Qing Lin He, Lei Pan, Alexander L. Stern, Edward C. Burks, Xiaoyu Che, Gen Yin, Jing Wang, Biao Lian, Quan Zhou, Eun Sang Choi, Koichi Murata, Xufeng Kou, Zhijie Chen, Tianxiao Nie, Qiming Shao, Yabin Fan, Shou-Cheng Zhang, Kai Liu, Jing Xia, Kang L. Wang. **Chiral Majorana fermion modes in a quantum anomalous Hall insulator-superconductor structure.**

### **To read more:**

*Science*, 2017; 357 (6348): 294  
DOI: [10.1126/science.aag2792](https://doi.org/10.1126/science.aag2792)

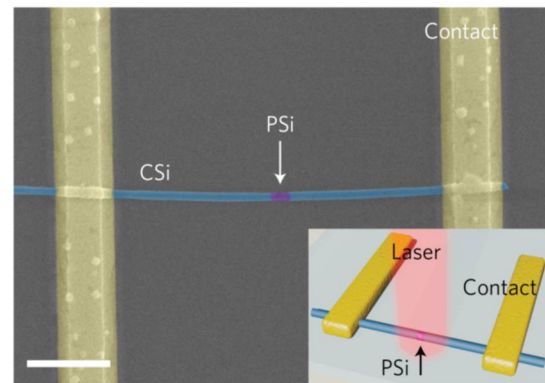

### **Photon-triggered nanowire transistors are reported in Nature Nanotechnology**

Kim et al., recently reported on photon-triggered nanowire (NW) transistors, a new step toward optical computing. These devices consist of crystalline silicon (CSi) NWs that include (PSi) segments in the middle and electrical contacts at both ends of the NW. The PSi acts as a reservoir and supplies carriers to the CSi

channel when is exposed to light. It allows for an on/off ratio as high as  $8 \times 10^6$ . Based on this method authors also demonstrated photon-triggered logic gates and a sub-micron resolution photodetector system.

### **To read more:**

<https://www.nature.com/nnano/journal/vaop/ncurrent/full/nnano.2017.153.html>

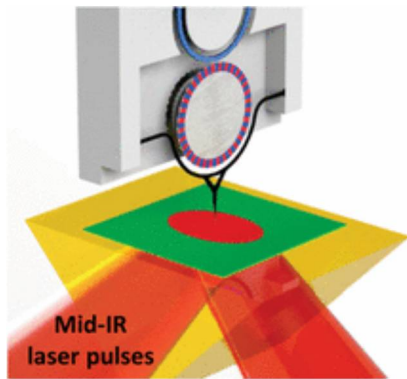

### Nanophotonic Atomic Force Microscope (AFM) transducers enable chemical composition and thermal conductivity measurements at the nanoscale

A near-field cavity optomechanics readout concept has been integrated with picogram-scale probes to realize fully functional AFM detection. This allows achieving high temporal resolution (<10 ns) and pico-

meter vertical displacement uncertainty simultaneously, breaking the trade-off between AFM measurement precision and ability to capture transient events.

Adapted with permission from Nano Lett., Article ASAP, DOI: 10.1021/acs.nanolett.7b02404. Copyright © 2017 American Chemical Society.

To read more:

<http://pubs.acs.org/doi/abs/10.1021/>

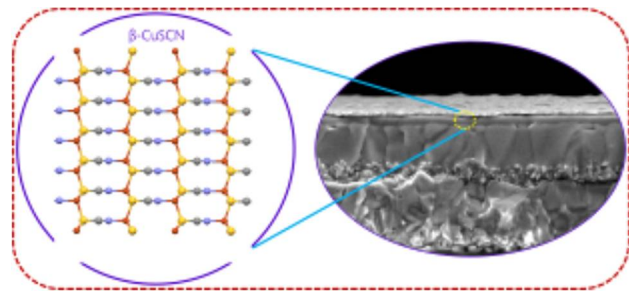

### Perovskite solar cells reach record long-term stability, efficiency over 20 percent:

Perovskite solar cells (PSCs) can offer high light-conversion efficiency with low manufacturing costs. But to be commercially viable, perovskite films must also be durable and not degrade under solar light over time. EPFL scientists have now greatly improved the operational stability of PSCs, retaining more than 95% of their initial efficiencies of over 20 %

under full sunlight illumination at 60°C for more than 1000 hours. The breakthrough, which marks the highest stability for perovskite solar cells, is published in Science.

#### More information:

"Perovskite solar cells with CuSCN hole extraction layers yield stabilized efficiencies greater than 20%" *Science* (2017). [s c i - e n c e . s c i e n c e m a g . o r g / l o o k u p / . . . 1 1 2 6 / s c i e n c e . a a m 5 6 5 5](https://www.sciencemag.org/lookup/doi/10.1126/science.aam5655)

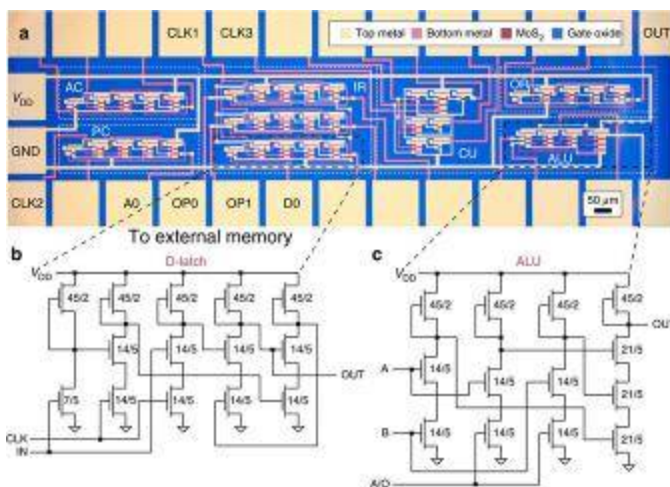

### Microprocessors based on a layer of just three atoms:

Researchers at Vienna University of Technology (known as TU Wien) in Vienna, Austria, have developed the world's first two-dimensional microprocessor — the most complex 2D circuitry so far.

Microprocessors based on

atomically thin materials hold the promise of the evolution of traditional processors as well as new applications in the field of flexible electronics. Now, a TU Wien research team led by Thomas Müller has made a breakthrough in this field as part of an ongoing research project.

Two-dimensional materials, or

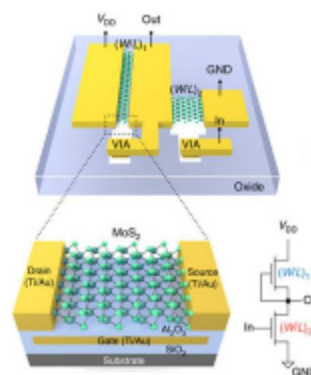

tonics Institute at TU Wien is conducting research into 2D materials, viewing them as a promising alternative for the future production of microprocessors and other integrated circuits.

**Original publication:** Stefan Wächter, Dmitry K. Polyushkin, Ole Bethge, Thomas Müller

[A microprocessor based on a two-dimensional semiconductor.](https://doi.org/10.1038/NCOMMS14948)

Nature Communications DOI: 10.1038/NCOMMS14948

2D materials for short, are extremely versatile, although – or often more precisely because – they are made up of just one or a few layers of atoms. Graphene is the best-known 2D material. Molybdenum disulphide (a layer consisting of molybdenum and sulphur atoms that is three-atoms thick) also falls in this category, although, unlike graphene, it has semiconductor properties. With his team, Dr Thomas Müller from the Pho-

## Announcements

### NASA Research Announcement: Use of the NASA Physical Sciences Informatics System Appendix D Released

The National Aeronautics and Space Administration (NASA) has released Appendix D of the NASA Research Announcement (NRA) NNH17ZTT001N, entitled "Use of the NASA Physical Sciences Informatics System." This NRA solicits ground-based research proposals from established researchers and graduate students to generate new scientific insights by utilizing experimental data residing in NASA's Physical Sciences Informatics (PSI) system (<http://psi.nasa.gov>), an online database of completed physical science reduced-gravity flight experiments conducted on the International Space Station (ISS), Space Shuttle flights, and Free-flyers, or from related ground-based studies. The proposals submitted in response to this NRA must present a compelling case on how the experimental data from the PSI system will be used to promote the advancement of further research. Proposers must show a clear path from the scientific data obtained from the PSI system to the proposed investigation. In addition, the project must address an important problem in the proposed area

of research and advance scientific knowledge or technology.

The main NRA will remain open for five years. There will be specific calls for proposals through a series of appendices, which are planned to be released yearly. This announcement is for the release of Appendix D, which solicits proposals in the five research areas for which experimental data will be available in the PSI system by the Appendix D proposal due date: Combustion Science, Complex Fluids, Fluid Physics, Fundamental Physics and Materials Science. The Appendix specifically solicits proposals that utilize data from 50 eligible investigations listed in the Appendix and on the PSI website. The Appendix will be amended, if necessary, with an updated list of eligible investigations before the proposal due date of December 15, 2017.

This solicitation is applicable to researchers in all categories of U.S. and non-U.S. organizations, including educational institutions, industry, nonprofit organizations, NASA Centers and other U.S. Government agencies. This NRA is soliciting proposals from two types of investigators: 1) established researchers, including postdoctoral scholars; 2) graduate students (with academic advisors) from accredited U.S. postsecondary institutions and programs. The proposals from graduate students must be

submitted by their advisor. Eligibility requirements and further instructions for both types of investigators are provided in the NRA. Principal Investigators (PIs) may collaborate with investigators from universities, Federal Government laboratories, the private sector, state and local government laboratories, and other countries.

The full text of the solicitation is available on the NASA Research Opportunities homepage at <http://nspires.nasaprs.com> under menu listing "Open Solicitations." The direct link to the umbrella solicitation is <http://tinyurl.com/NRA-NNH17ZTT001N>. The direct link to the Appendix D webpage is <http://tinyurl.com/NASA-17PSI-D>. Questions with regard to responding to this NRA may be addressed to the contacts referenced in the full solicitation document.

Notices of Intent for Appendix D are due on October 31, 2017, and they must be submitted electronically via NSPIRES (<http://nspires.nasaprs.com/>). Proposals are due on December 15, 2017, and they must be submitted electronically by an authorized official of the proposing organization using either NSPIRES (<http://nspires.nasaprs.com/>) or Grants.gov (<http://www.grants.gov>).

Every organization that intends to submit a proposal in response to this NRA must be registered with NSPIRES, and such registration must identify the authorized organization representative(s) who will submit the electronic proposal. Instructions on how to register in NSPIRES are provided in the NRA. Each electronic proposal system places requirements on the registration of principal investigators and other participants (e.g., co-investigators). Potential proposers and proposing organizations are urged to access the system well in advance of the proposal due date to familiarize themselves with its structure and enter the requested information.

NASA plans to conduct a proposers' conference via WebEx on October 17, 2017. Prospective proposers are advised to monitor the solicitation webpage for further information on the conference, including instructions on how to submit your questions about the PSI or the NRA.

This is a broad agency announcement as specified in FAR 6.102 (d)(2). Notwithstanding the posting of this opportunity at Fed-BizOpps.gov, [nspires.nasaprs.com](http://nspires.nasaprs.com), or Grants.gov, NASA reserves the right to determine the appropriate award instrument for each proposal selected pursuant to this announcement.