

IEEE New York Monitor

Advancing Technology for Humanity

May 2012, Vol. 60, No. 5



EPICS-in-IEEE around the world

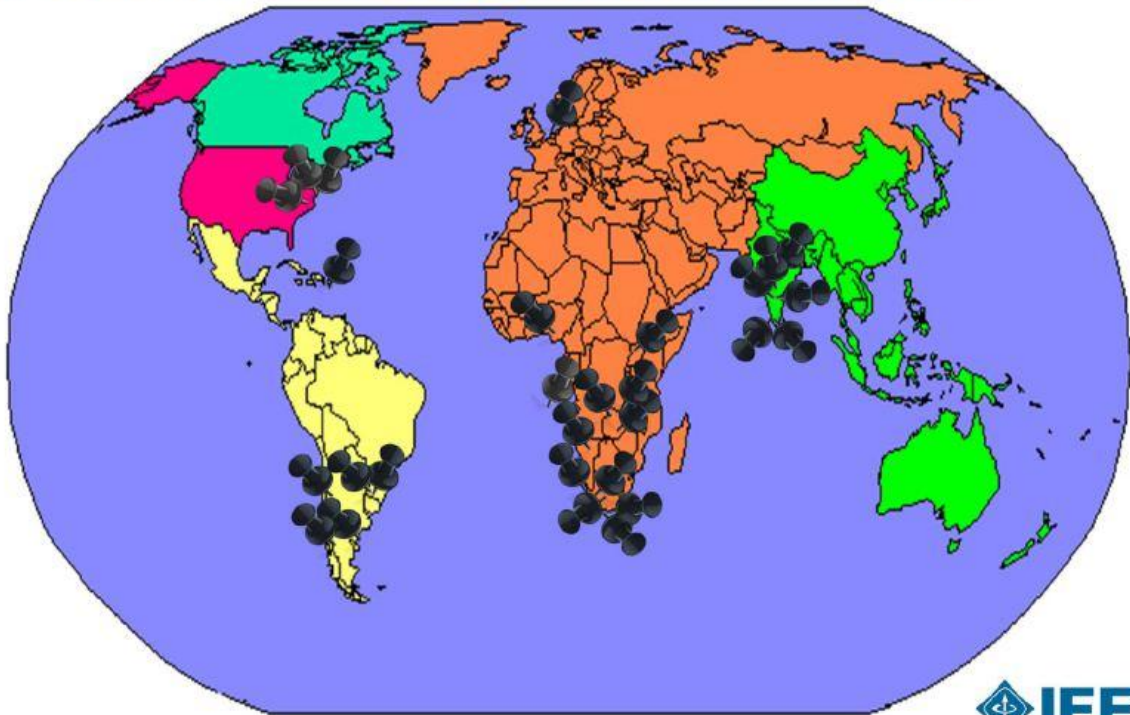

The IEEE New York Section Executive Committee (2012)

Section Officers

Section chair: Balvinder Blah, Con Edison Co.
Section vice chair (Chapter operations): Shu-Ping Chang, PhD: IBM Thomas J. Watson Center
Section vice chair (Section activities): Kai T. Chen, NYC Transit
Section treasurer: Michael Haroutunian, NYC Transit
Section secretary: Wilson Milian, NYC Transit
Past Section chairs: Darlene Rivera, McKissack & McKissack
David Horn: McKissack & McKissack

Society chapter chairs

Broadcast Technology: William C. Miller, Mitag Media Technology, LLC
Computational Intelligence: Alevoor Ravishankar Rao, PhD, IBM
Computer: Sofia K. Georgiadis, NYC Transit
Communications: Konal Kumar, NYC Transit
Technology Management: David M. Weiss, Systra Consulting, Inc.
Engineering in Medicine and Biology: Matthew R. Irwin, Visual MD.com
Instrument and Measurement: Steven Giavasis, Polytechnic Institute
Power and Energy / Industrial Applications: Arnold Wong, Consolidated Edison
Vehicular Technology: Patrick McGettigan, LTK & Associates, and Mark Woodward, CH2M Hill
Solid State Circuits/Electron Devices: Harish Krishnaswamy, Columbia University

Affinity Group Chairs

Graduates of the last decade (GOLD): Michael Haroutunian, NYC Transit
Life Members: Ralph Mazzatto, Independent consultant
Women in Engineering (WIE): Jean Redmond, Johnson Controls, Inc.
Consultants Network: Martin Izaak, Urban Engineers

Section Committee chairs

Awards & Recognition: Wilson M. Milian, NYC Transit
Operations & Procedures: William N. Coyne, Independent consultant
Career Guidance: Stanley Karoly, NYC Transit
Chapter Organization/Society Liaison: Darlene E. Rivera, McKissack & McKissack
Conference Coordinator: Charles Rubenstein, PhD, Pratt Institute
Education: Leon Nock, Independent consultant
Historian: Mel I. Olken, Editor-in-Chief, IEEE Power & Energy Magazine
Long Range Planning: William Perlman, Independent consultant
Members-at-Large: Peter Mauzey, Independent consultant and Paul Sartori, Con Edison Co.
Membership Development: Neil Weisenfeld, Con Edison Co.
Metro. Engineering Society Council: Michael Miller, Independent consultant
Metro. Section Activities Council: Darlene E. Rivera, McKissack & McKissack
Professional Activities: Robert M. Pellegrino, Independent consultant
Publications: Darlene E. Rivera, McKissack & McKissack
Publicity/Public Relations: Ken Vought, RT&T Consultants
Special Events: Ralph Tapino, Independent consultant
Student Activities: Kim K. Smith, NYC College of Technology
Tappan Zee Sub-Section: Robert M. Pellegrino, Independent consultant
Webmaster: Harold Ruchelman, Independent



Fostering technological innovation and excellence for the benefit of humanity

New York Section



May, 2012, vol. 60, No. 5

Editor: Amitava Dutta-Roy, PhD, Life Fellow

CONTENTS

Please link on the desired item
A few words from the Editor
Ready links to the Calendar of Events for the following Sections are given in the anchor page (please access the pdf document) NEW YORK Long Island North Jersey New Jersey Coast Connecticut
Quotation of the Month
Notable happenings in May in the years gone past Events and birthdays of the giants on the shoulders of whom we stand today
News from the NY Section and the IEEE Notification re Nomination of Section Officers for 2013 Notification of Nomination of Officers for PES/IAS Chapters for 2013 Lower Hudson Valley Engineering Expo Robert M. Pellegrino IEEE – USA Free e-books from the IEEE-USA New Innovation Measurements
Engineering Projects in Community Service EPICS — in — IEEE — Humanitarian and Education Initiative
Dr. Roy Rosser on Patents
A Slot in the Road Manhattan’ Forgotten Electric Trolley System Gilmore G. Cooke, PE, LSM <IEEE Boston Section>
Tidbits Skydrive

Contributors and collaborators:

The Monitor thanks all contributors and collaborators towards the compilation of this edition of the Monitor: Mr. Gilmore Cooke, PE, LSM of the Boston Section (the article on Fred S. Pearson; Dr. Roy Rosser (slides of his presentation of patents); Mr. Bob Pellegrino, SM and chair of the NY Tappan Zee Subsection (on Lower Hudson Valley Engineering Expo); and Dr. Kapil Dandekar, IEEE SM, Associate Dean of Research at Drexel University, Philadelphia and Prof. Saurabh Sinha, IEEE SM, University of Pretoria, South Africa (for the slides and the audio clip on EPICS – in IEEE).



Jacob Javits Convention Center lit up, New York where many engineering and computer-related expos are held

A few words from the Editor

A random sampling of the e-mails we received from readers of the Monitor, both from inside and outside the New York Section shows that it is being well received. We thank our contributors, collaborators and readers for their time and good wishes. However, we would like to get more feedback from our readers. Any suggestion in this respect will be much appreciated.

This month we have changed the “Birthday section” to “Notable happenings.” This section will give you data from unexpected quarters and make the section somewhat funny and interesting to read. Do you know who patented the first fountain pen or that almost three hundred years ago a London lawyer received a patent for the world’s first machine gun? True, you could have found the answers through search engines. But we did all the work for you.

This edition of the Monitor contains new tabs in the sidebar. Four of them are still available on the menu bar on the top. We wanted to introduce another tab that when clicked would reveal earlier issues of the Monitor. However, due to the restrictions on the number of tabs on the top available on the IEEE template this tab and others have been placed on the sidebar. Also, for this reason the “About us” item has been moved below that when clicked reveals information on the IEEE and the New Section in particular. When “Earlier issues” button is clicked you will see a dropdown menu and the pdf versions of old Monitors. We have included all editions (1998 – 2010) that were made available to us. We hope that you will make use of this feature and read about the history of the New York Section. We believe that editions that are missing from this list do not really exist anymore.

This is the first time we have introduced audio clips in the Monitor page. We have tried it and it works quite well. You might find that, depending on the bandwidth, it may take a few minutes to load. This audio clip and the accompanying slide show have been embedded here with the permission from the coordinators of **Engineering Projects in Community Service or EPICS — in —IEEE — Humanitarian and Education Initiative**. You will find it interesting to note how some IEEE members are engaged in community services through 28 ongoing projects in 11 countries. You may also like to contribute your talents to this initiative.

Boston Section’s historian Mr. Gilmore Cooke has contributed an article (originally presented at the IEEE Conference on the history of electric power at New Jersey Institute of Technology, Newark in August, 2007) that would be particularly interesting to the New Yorkers. It deals with the early attempts by the gifted engineer Fred Stat Pearson to deploy electric trolleys in New York and the 96th Street power station. Those with links also with Latin America may note that Pearson created the massive business houses in Brazil (São Paulo Tramway, Light and Power Company) and Mexico (Mexican North Western Railway, the Mexican Tramway Company, and the Mexican Light and Power Company). “A man for all seasons,” indeed.

We have also embedded the slides from the presentation on patents that given by Dr. Roy Rosser at the fourth monthly meeting of PES/IAS/LMAG meeting on April 24 of this year. Those who are inclined

to apply for a patent may well look at the slides and, if necessary, contact the author. His e-mail address is given on one of the slides.

Lastly, in the Tidbit section there is a suggestion for parking your photos and other documents up in the sky. The facility is provided by the giant Microsoft and happen to be free (at least, for now). Hope you will enjoy reading all or parts of the Monitor!



Students involved in one of the EPICS project

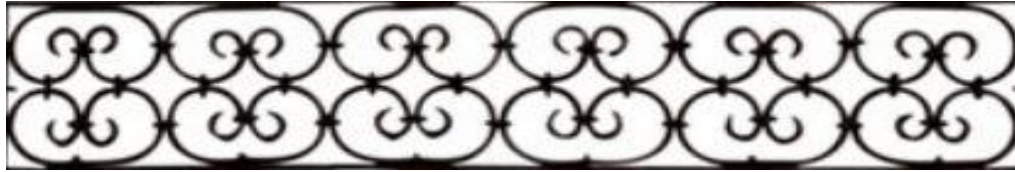

He spoke thus:



Content makes poor men rich; discontentment makes rich men poor

Benjamin Franklin

(January 17, 1706 – April 17, 1790)



Notable happenings in the month of May during the years gone past

May 1, 1888: **Nikola Tesla** (July 10, 1856 – January 7, 1943) received patent No. 382,280 from the US Patent Office for inventing the transmission of electrical power

May 4, 1943: **Igor Sikorsky** (May 25 – October 26, 1972) obtained patent for control system for helicopters

May 10: **Benjamin Franklin** (January 7, 1706 – April 17, 1790) tested his lightning rod for the first time. Besides the invention of the lightning rod Franklin was also the inventor of iron furnace stove and bifocal glasses.

May 12: **Otto Mergenthaler** (May 11, 1854 – October 28, 1899) invented received his patent for producing printing bars, a forerunner of linotype machine.

May 15, 1718: **James Puckle** (1667 – 1724): a London lawyer patented the world's first machine gun.

May 19, 1896: **Edward Goodrich Acheson** (March 9, 1856 - July 6, 1931), American chemist received the patent for his electric furnace to produce carborandum, one of the hardest industrial substances .

May 20, 1830: **D. Hyde of Reading**, PA received the patent for the continuous flow fountain pen.

May 20, 1851: **Emille Berliner**, German who invented the gramophone was born. He died on August 3, 1929.

May 22, 1819: Bicycles (aka "swift walkers") were introduced in the U.S.A.

May 22, 1906: **Orville and Wilbur Wright** received the patent for their motorized "flying machine."

May 27, 1796: **James McLean** received patent for his piano.



Call for Nominations for Officers of the IEEE New York Section for Calendar Year 2013

The Nominating Committee of the IEEE New York Section is soliciting nominations for the following IEEE New York Section Officer and Chair positions for calendar year 2013:

Section Officers

Chair
Vice Chair – Chapter Operations
Vice Chair – Section Activities
Treasurer
Secretary

Section Working Activity Chairs

Operations & Procedures Manual Committee
Chapter Organization
Historian
Long Range Planning
Publications
Webmaster

The term of office for the elected Section Officers and Working Activity Chairs is for one calendar year starting in January 2013 and ending at the end of December 2013. IEEE New York Section members in the grades of Graduate Student Member, Member, Senior Member, Life Member and Fellow are eligible, as long as they are members in good standing, to hold office in the IEEE New York Section. Please ensure that the individuals or individuals nominated are both eligible and willing to serve in the proposed position.

Nominations, in addition to those made by the Nominating Committee, will be accepted when made by petition only after prospective candidates have submitted their request to run for Executive Committee position by June 15, 2012 and have been vetted by the Nominating Committee. Section members who do not submit their name as a prospective candidate by the June 15th deadline will not be considered for any officer position for the coming year. Prospective candidates for officer position not endorsed by the Nominating Committee will be notified by July 10, 2012 to submit their petition by “Priority Mail with Tracking” or “Registered Mail” and sent separately to the NY Section Chair and Secretary and received by them postmarked no later than August 10, 2012. In order for such petition to be valid it shall carry the signatures of at least one percent of the voting members of the New York Section except in no case shall more than 25 NY Section members be required. **NOTE: Petition Candidates are limited to choosing only one NY Section Executive Committee Officer position.**

Nomination requests should be e-mailed or postmarked no later than June 15, 2012, and should be addressed to the undersigned.

Darlene Rivera
IEEE New York Section
Chair Nominating Committee
Address: 794 Barberry Road, Yorktown Heights, NY 10598
E-Mail: drivera938@ieee.org

Call for Nominations for Officers

of the

IEEE New York Section PES/IAS Chapters for Calendar Year 2013

The Nominations Committee of the IEEE New York Section PES/IAS Joint Chapter is soliciting nominations for the following Chapter office positions for the January 1, 2013 to December 31, 2013 term:

- Chair
- Vice Chair
- Treasurer
- Secretary
- Senior Member at Large
- Junior Member at Large

IEEE New York PES/IAS Chapter members with the grade of Graduate Student Member or higher (Member, Senior Member, Fellow, Life Member) are eligible to hold office, as long as they are members in good standing (current dues paid), in the IEEE New York Section, PES/IAS Chapter. Please ensure that the individuals or individuals nominated are both eligible and willing to serve in the proposed position.

Nominations should be e-mailed or U.S. Mailed postmarked no later than June 15, 2012 and mailed to:
William F. Montgomery, Past Chairman 2011

IEEE NY Section PES/IAS Joint Chapter

Chair Nominations Committee

16-49 212th Street

Bayside, NY 11360

bill.montgomery@ieee.org

IEEE NEW YORK PES/ IAS JOINT CHAPTER ACTIVITIES

Chapter Executive Committee (EXCOM): includes a Chair, Vice Chair, Treasurer, Secretary, Senior-Member-at Large, Junior-Member-At Large and ten standing committees. The monthly meetings are held at Consolidated Edison Company headquarters, since many members of the Committee are Con Edison employees. The following activities of the Chapter are coordinated by the EXCOM and its monthly meetings.

Awards Committee: Strives to provide recognition for all members who qualify for advancement and recognition. Qualified Members of Chapter's Executive Committee Members are advanced to Senior Member. New Executive Committee Members are encouraged and supported to upgrade membership

once qualified. Services by individual members are formally recognized and are honored with the presentation of certificates or plaques at the Chapter's annual Awards ceremony.

Education Committee: Coordinates with PERC Inc. for P.E. review course sessions in all three major disciplines. The students attend classes in preparation for the Spring and Fall Professional Engineering License exams.

Membership Development Committee: In cooperation with Technical, Program, Education and other Committees meetings, encourages non-members to join IEEE and current members to stay active with IEEE activities especially the PES/IAS Chapter. The MD Committee continues to educate IEEE members on the numerous benefits of IEEE membership. The current MD Chair has worked closely with the NY Section's GOLD Programs, Women in Engineering, Society of Hispanic Professional Engineers, and the American Association of Blacks in Energy Programs to foster new membership.

Program Committee and Technical Discussion Committee: Together these committees arrange for 12 presentations a year, which include both electrical engineering technical and non-technical issues. A CEU Program was established in 2007 to encourage Professional Engineers to attend and benefit from our monthly presentations and receive continuing education credits.

Public Affairs Committee: Prepares letters to local elected politicians offering the Chapter's technical support in case help is needed to explain power and energy issues in the NYC area. Also, advertises in local college and university newspapers the importance of engineers in our daily lives.

Publicity Committee: Maintains the Best Customer mailing list for use in notifying previous attendees (members and Non members) of upcoming monthly Program and Technical Discussions. The committee also ensures that PES/IAS Chapter meeting announcements are advertised via IEEE e-notice and on our website.

Special Events Committee: Supports regional, section and society events as required especially for events presented locally.

Student Activities Committee: Develops strong relationships with the IEEE students' branches at NY area colleges and universities. As an example we have cooperated with NYU-Poly in presenting activities of interest to students and future PES/IAS IEEE members.

Chapter Web Master: maintains and updates the website: <http://ewh.ieee.org/soc/pes/newyork/>

Lower Hudson Valley Engineering Expo

Robert M. Pellegrino



[In our last edition we published a report on this year's Lower Hudson Valley Engineering Expo. In this edition of the Monitor we have another short report from Mr. Robert M. Pellegrino, chair of the Tappan Zee Subsection. Mr. Pellegrino was at the expo and took part in the activities of the day, Sunday, March 25, 2012. The expo is an important event for the IEEE Sections in the tri-state area. The objective of the expo has always been to motivate the young students to study engineering. At this expo the future engineers can converse with the practicing engineers and hopefully this would help the young to make the right choice for their careers. It is our pleasure to include this eye witness account of the expo from Mr. Robert M. Pellegrino who has spent many years as an engineer with ConEd and is currently the chair of the Tappan Zee Subsection.]

The Chair and Vice Chair, Robert M. Pellegrino and Jinjun Xiong of the IEEE Tappan Zee Subsection, Jean Redmond, Chair of the New York Section Women in Engineering (WIE) Affinity Group and Kim Smith, Chair of the NY Section Student Activities Committee participated in the 9th Annual Lower Hudson Valley Engineering Expo held on March 25, 2012 at White Plains High School, White Plains, NY. Parents and students from various Westchester, Rockland and Putnam County schools attended the event.

Exhibitors included engineering companies from the various engineering disciplines such as electrical, mechanical, civil and chemical industries as well as their respective engineering professional socie-

ties such as IEEE, SME, SAE, ASCE, ASCHE, etc. Representatives from in-state and out-of-state colleges and universities also attended this event to discuss their engineering programs and projects.

There was excellent interaction between parents, students and IEEE New Section representatives to learn about IEEE. We explained that IEEE is the world's largest professional engineering organization for the advancement of technology. IEEE creates engineering standards, holds technical conferences throughout the world and enhances the careers of all of its members. Electrical engineers can specialize



in a number of different fields such as power, communications, computers, robotics, broadcast technology, bio-medical engineering, etc. We also explained the purpose of the NY Section and local Tappan Zee Subsection and discussed a number of the presentations on computers, solar energy, patent law, etc. given at our meetings by local engineering subject matter experts. Each of us encouraged the students to join the IEEE when they get to college and to continue their membership when starting their professional careers. Some contact information was exchanged between some

teachers and business professionals, who were looking for IEEE to give a presentation to their students or organization.

The 2012 Lower Hudson Valley Engineering Expo was another successful event for the IEEE New York Section and the student community!

Senior Members of the IEEE at the New York Section

We are happy to inform our readers that at the Admission and Advancement (A&A) Meeting held at Dallas, TX on April 21, 2012 the Review Panel has approved the elevation of **Mauricio Porfiri** and **Dustyn Roberts** of the New York Section to the grade of Senior Members. The Monitor congratulates both of these senior members.

The total number of members in Region 1 elevated to Senior Grade this year has so far been 83 while the goal is to reach 215. The next meeting of the A&A Review Panel is scheduled to be held in Tokyo, Japan on June 2, 2012.

News from the I E E E - U S A you might have missed

NEWS from IEEE-USA
2001 L Street, N.W., Suite 700
Washington, DC 20036-4910

IEEE-USA's Free E-Books to Members in May & June Feature Innovation & Finding the Perfect Job

WASHINGTON (15 May 2012) -- As a special benefit to IEEE members in May, IEEE-USA is offering a free e-book, "Innovation Conversations, Book 1: The Innovation Process." In June, the free e-book will be "Launching Your Career, Book 1: How to Find Your Perfect Job."

Innovation means much more than just coming up with creative ideas; those ideas have to be put to work to create a benefit. Innovation can be seen as a journey that starts with setting a purpose or goal and blossoms into innovative achievement and new learning. Along the way, innovative thinking is required. So is knowledge and values.

In "Innovation Conversations," renowned innovation author, William C. Miller, provides a way for readers to understand the process of innovation. And he demonstrates how people of any technical job can apply it to the challenges and opportunities they find in their day-to-day work.

"Innovation Conversations, Book 1: The Innovation Process" can be downloaded at <http://www.ieeeusa.org/communications/ebooks/files/viij2812/Innovation-Styles-Book1.pdf> for free to IEEE members. The nonmember price is \$7.99.

IEEE-USA's free e-book in June, "Launching Your Career Book 1: How to Find Your Perfect Job," will help you define your personal, long-term career goals and provide a practical roadmap to assist in finding your ideal job.

Author Abby Vogel Robinson provides tools and assessments to enable you to evaluate your personality and aspirations, find a great company to work for, choose the best position for you and build your network. Your career decisions will play a major role in determining your income, community status, circle of friends, choice of a spouse -- and even your identity and sense of self-worth. It will also help you choose wisely and carefully and get you started toward personal and professional fulfillment.

This e-book will be available for members to download for free in June.

To purchase IEEE member-only products and to receive the member discount on eligible products, members must log in with their IEEE Web Account.

Call for Authors

IEEE-USA E-books seek authors to write an e-book or a series on career guidance and development topics. If you have an idea for an e-book that will benefit members on a particular topic of expertise, email your proposal to IEEE-USA Publishing Manager Georgia C. Stelluto at g.stelluto@ieee.org

IEEE-USA advances the public good and promotes the careers and public policy interests of 210,000 engineering, computing and technology professionals who are U.S. members of IEEE.

Web: www.ieeeusa.org

Facebook: www.facebook.com/ieeeusa

Twitter: www.twitter.com/ieeeusa

Join IEEE: www.ieee.org/join

Contact: Sharon C. Richardson, Coordinator
IEEE-USA Communications & Publishing
Phone: 1 202 530 8363
E-mail: s.richardson@ieee.org

NEWS from IEEE-USA
2001 L Street, N.W., Suite 700
Washington, DC 20036-4928

Labor Economist Richard Freeman to Liken New Innovation Measurement to GDP at STEM Enterprise Event at AAAS in June

WASHINGTON (17 May 2012) -- Leading labor economist Dr. Richard Freeman will liken a new way of measuring innovation to GDP during his keynote address at a STEM measurement workshop in Washington, D.C., on Wednesday 6 June.

Held at the American Association for the Advancement of Science, "STEM Enterprise: Measures for Innovation and Competitiveness," is designed to measure the impact and effectiveness of all public, private and academic money spent on research and development in the STEM (science, technology, engineering and mathematics) area.

Workshop sessions will focus on four main areas: funding, workforce, output measures and indicators, and policy implications. For more information on the all-day event and to register, see <http://www.ieeeusa.org/calendar/conferences/stem/default.asp>.

Freeman, a Harvard University professor, contends that the usual methods of assessing innovation, e.g. R&D spending or number of patents granted, are not true measures of innovation, which he defines as "the creation of improved goods or services, or modes of production that are brought to the marketplace for sale or delivery to consumers, firms or the government."

According to Freeman, the absence of a general quantitative measure of innovation "mars our ability to analyze the magnitude and direction of innovation and to develop policies to encourage it. I describe a new way of putting together a genuine measure and database of innovations, based on Web-scraping product announcements and lists of top innovations from various industry and other sources that would be the innovation equivalent of GDP [gross domestic product].

"I argue that this is the next key step in social measurement necessary for us to understand the new economics of a knowledge-based economy. I will also talk about some related innovative uses of Internet-based data to produce 'leading indicators' of the direction of science and innovation."

The workshop is organized by IEEE-USA, AIChE, AIME, ASCE and ASME and supported by a grant from the United Engineering Foundation. Cosponsors include AAAS, ASTRA, SME, Thompson Reuters and Northrop Grumman.

IEEE-USA advances the public good and promotes the careers and public policy interests of 210,000 engineering, computing and technology professionals who are U.S. members of IEEE.

Web: www.ieeeusa.org

Facebook: www.facebook.com/ieeeusa

Twitter: www.twitter.com/ieeeusa

Join IEEE: www.ieee.org/join

Contact: Chris McManes
IEEE-USA Public Relations Manager
202-530-8356
c.mcmanes@ieee.org

Engineering Projects in Community Service or EPICS — in —IEEE — Humanitarian and Education Initiative

This 2007 IEEE initiative was conceived and championed by the 2007 IEEE president Leah Jamieson, an IEEE Fellow and formerly the John A. Edwardson dean of Engineering and Ransburg Professor of Electrical and Computer Engineering at Purdue University, West Lafayette, IN. Since then it has spread in various parts of the world. Currently, EPICS has 28 ongoing projects in 11 countries. Recently, the coor-

dinators offered a global Webinar that showed snippets from different projects. In this edition we are happy to embed the slides of the presentation and the audio and video recording of the same. The latter is 1 hour and 5 minutes long. However, we recommend you to “attend” this Webinar, since the concept is in tune with the IEEE’s motto of “advancing technology for humanity.” Just go to the anchor page and click on the appropriate line.

Patents for Smart People who have No Time to Waste

Roy Rosser

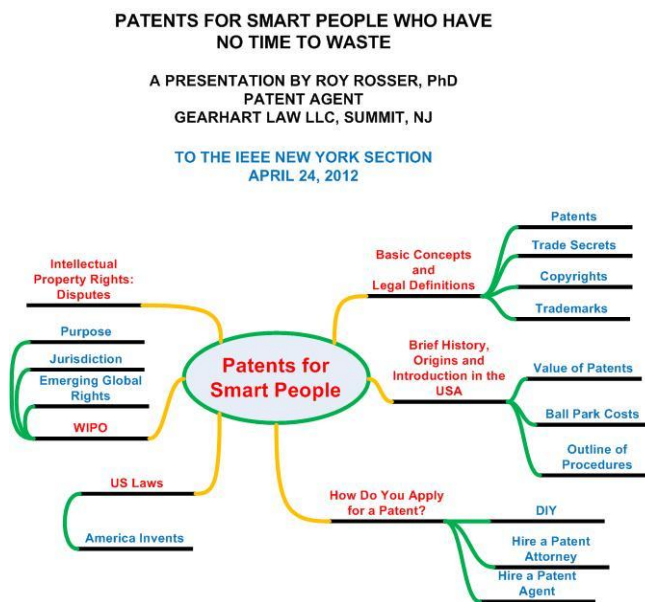

On April 24, 2012 Roy Rosser, a PhD in physics and entrepreneur gave a presentation on the above topic at this fourth meeting of the PES and IAS chapters and the Life Members’ Affinity Group of the New York Section. It attracted more than 70 attendees. Dr. Rosser introduced the concepts behind the intellectual property rights. He also mentioned pros and cons of DIY patent projects. We are happy that Dr. Rosser has given us the permission to embed his presentation slides in this issue of the Monitor. Please go to the anchor page and click on the appropriate button.

The Slot in the Road: Manhattan's forgotten underground electric trolley system

Gilmore G Cooke*

[This article reveals the engineering accomplishments in the planning of a Manhattan electric trolley system by a gifted engineer Fred Stark Pearson who was born in Lowell, Massachusetts, on July 3, 1861 and died on May 7, 1915. Pearson graduated from Tufts University in the early 1880s. He managed to squeeze in a prolific engineering career before boarding the illfated RMS Lusitania bound for England with his wife on May 2, 1915. Five days later Lusitana was torpedoed by a German U-boat near the coast of Ireland. Pearson was president and founder of Brazilian Traction, Light and Power Company Limited, the Mexican Light and Power Company Limited, Mexico Tramways Company and Barcelona Traction, Light and Power Company Limited. He died at the age of 54. The author Gil Cooke of the IEEE Boston Section is currently working on Pearson's comprehensive biography. The original version of this paper was presented at the IEEE Conference on the history of electric power at New Jersey Institute of Technology, Newark in August, 2007. Here it is being republished with the permission of the author. – Editor.]



The beginning

Because of city regulations, overhead wires, and electrical poles were not permitted in the borough of Manhattan. The unintended consequence of this ban was prohibiting conventional electric overhead trolleys from the streets of New York City. The only mode of public transportation allowed in the early 1890s, was either horse-drawn streetcars or cable-drawn cars, both expensive to operate and socially and technically undesirable. This ban would become an opportunity for entrepreneurs to find a solution to this problem with the Slot in the Road.

The slot or electric conduit was Manhattan's unique mass transit system launched by a very progressive company over a century ago. The conduit system was used to propel streetcars, or trolley cars, by electricity coming from a source located underground, between the tracks, instead of overhead wires. In traction terminology, this type of traction is a 'subsurface double conductor system with metallic return'. As you will see, the electric conduit was very different than the third rail for subways.

Metropolitan Street Railway Company of New York was incorporated in the early 1890s to acquire and consolidate existing street railway lines, then provide an acceptable transportation system for Manhattan, an island approximately thirteen miles long and one and a half mile wide. The company was founded and initially financed by a syndicate from Philadelphia, headed by William Whitney, joined by P.A.B. Widener, W. Elkins, George Kuhn, and others. Engineering and construction were under the leadership of thirty three year old chief engineer Fred Stark Pearson (1861-1915). Pearson was assisted by a

staff of engineers, some of which had previously worked for him in Boston on the West End Street Railway electrification project.



Figure 1 -The mechanical San Francisco type cable was introduced on Broadway Avenue in 1892, giving New Yorkers improvements in travel and comforts over horse-cars. Courtesy of A. Lonto.

Because of the ban on overhead wires, New York City was way behind the time in public transportation, with no end in sight. This was partially rectified in 1892 when a mechanical cable was installed along Broadway (Figure 1). The Broadway Cable Company attempted to replace horse-drawn cars along this major thoroughfare. Sometime later, Metropolitan purchased the Broadway Cable Company as well as many independent horse-drawn streetcar companies. These were brought into Metropolitan's integrated system either by purchase or lease. The Broadway cable was substantially strengthened, expanded, and the line upgraded. Once upgraded, this road became the backbone of the company's business. It was the last transit line converted to electricity in 1900.

After a series of acquisitions, Metropolitan Street Railway Company began to modernize its system by first installing new cable lines. I believe these additions were stopgap measures, temporary measures, to give company engineers time to develop a permanent electrical solution. Two major cables were installed, one on Columbus Avenue and the other on Lexington. At one time in the city's history, there were six cable traction lines operating in the borough of Manhattan. Although temporary, they were substantially well built. Each line was equipped with a duplex system consisting of two sets of drives carrying two active steel ropes on separate sets of sheaves. Steel ropes had diameters of up to two and a half inches. Duplex systems were specified because traction apparatus would be subjected to great wear and strains, in addition, ropes would have to be replaced regularly. A duplex system gave

them the capability of making repairs on-line, for example, allowing any one rope to be inspected, repaired, or replaced while streetcars remained in motion by hanging onto the active rope.

Throughout his engineering career, Pearson's work was always guided by one principle or criteria: 'certainty of operation'. Certainty of operation is believed to have been first coined in 1852 by Dr. Chan-ning when specifying requirements for his telegraph fire alarm system in Boston. Pearson used the phrase in 1899 in his article on the history and development of the conduit for New York City. It meant highly reliable service, or a system having a high availability. In addition to the duplex cable systems mentioned previously, there is plenty of evidence that this criteria was applied throughout the design of the electric conduit.

Electric traction as the solution

The conceptual idea for the New York system was based on the Siemens and Halske conduit (Figure 2), a commercial system that had been running for six years in Budapest, Hungary. Fred Pearson traveled to Budapest and Berlin in 1894 to investigate this system. After consulting with their engineers in Berlin, Pearson returned to New York to recommend to the Board of Directors that a conduit, similar to Siemens and Halske, be installed on a trial basis, after all necessary improvements had been made to satisfy environmental and operating conditions.

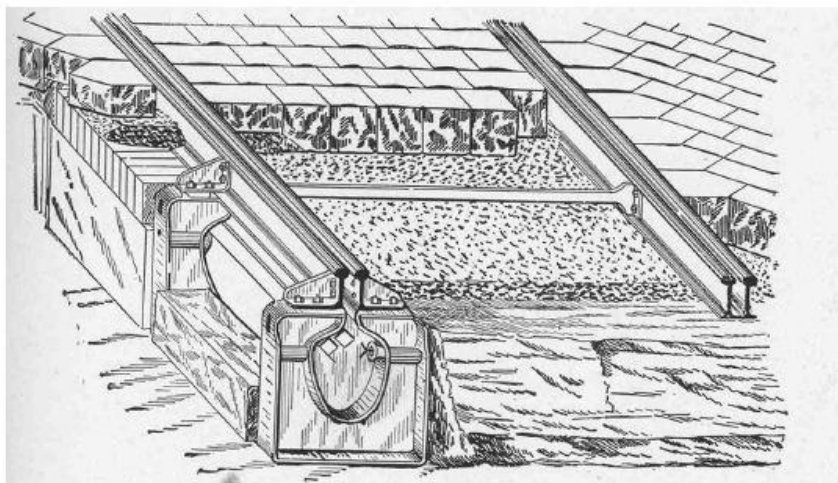

Figure 2 -The Siemens and Halske conduit was a lightweight design with the slot illogically placed below a special track, shown here on the left.

Landmark trials on Lenox Avenue, 1895

On 9 March 1895, Metropolitan Street Railway Company announced plans to build and test a new underground electric trolley on Lenox Avenue in Harlem (Figure 3). The conduit under test would be based on the Budapest design but would incorporate many improvements, such as, a narrow slot located in the middle of the tracks, to match existing cable design. Should the electric conduit experiment

prove to be unworkable, the road could always be converted to mechanical traction. Fortunately, the Lenox experiment was a complete success, resulting in the first practical electric conduit installation in this country.

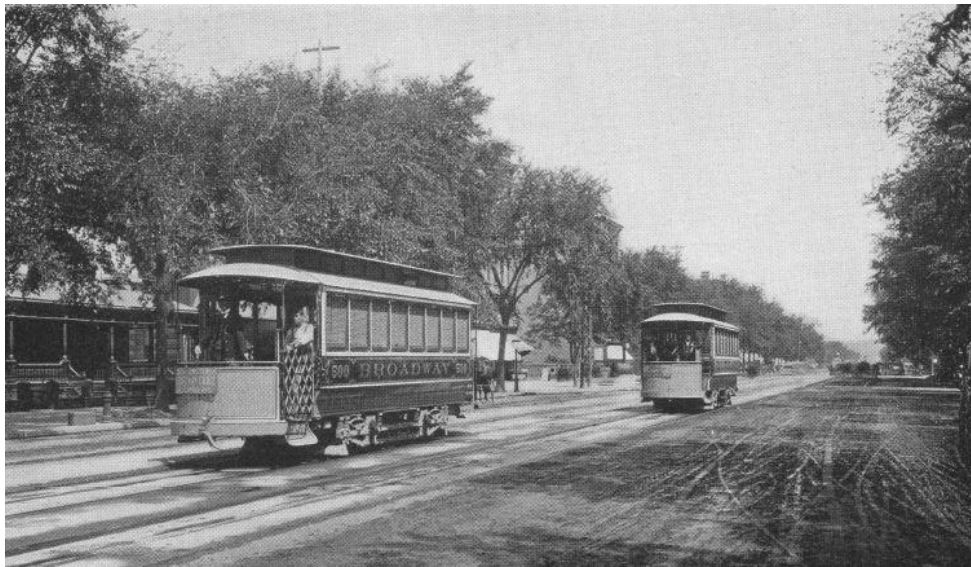

Figure 3 – The famous trial on Lenox Avenue in 1895 were well publicized in the engineering press and New York Times

The trials on Lenox Avenue consisted of electrical, mechanical, materials, structural and civil engineering tests. For example, extensive electrical tests were conducted to determine whether a potential of 300 volt dc or 600 volt worked best when electrical components are buried underground. 600 volt dc was ultimately found acceptable. Additional experiments were conducted to determine the best way to attach insulators and conductor rails; whether components should sit on concrete pedestals, or be supported hanging down from the yokes above. Ultimately, the latter method was adopted system wide.

Drainage pipes, water collecting basins, sump pumps, all had to be properly sized to prevent flooding the conduit during maximum rainfall. Since there were no standards to go by, field tests were conducted to validate initial design. Structures, foundations, iron supports, slot rails, duct banks, and man-holes, were subjected to heavy 'live' vehicular loads. Interestingly, according to photographs discovered at the Schenectady Museum, project engineers employed a full-scale mockup presumably to refine their design or to train personnel for construction, or both.

While the Lenox Avenue conduit was being built, another transit company serving Washington DC, also compelled to adopt some form of traction other than the overhead trolley, came to New York to meet with engineers and checkout the electric conduit. They adopted a similar design, commencing work in March 1895. These two roads were completed at about the same time.

Building the system

In 1896, Metropolitan Street Railway Company committed itself to electrifying their entire transit system, and to completing the work as rapidly as possible. There were sound economic or business reasons for doing so. This point can be demonstrated by the following comparison involving horse-drawn cars versus electric conduit. In earlier days, horse-drawn cars made the twenty-six mile round trip from one end of Manhattan to the other, and return, in about three hours. Less than 200 cars were needed to handle the paying passengers making the trip. With new electric cars, the round trip was made in less than two hours. Some 300 cars, each car with nearly double the seating capacity, were required for the growing number of passengers. Electrifying public transportation promised to be a very profitable business.

Their strategic plan called for rebuilding all major horse-drawn lines running north and south on both side of Central Park and converting them to electricity. This phase of the project involved multiple contractors working night and day on two or more roads simultaneously. Fourth Avenue, Madison Avenue, Central Park West, Amsterdam Avenue, Eighth, Sixth Avenue, then Second Avenue, all were completed in rapid succession. Fourth Avenue was the first long electric road to be placed in service. One can follow the progress of construction along city streets by reading the reports given to the New York Times.



Figure 4 -This 1897 photograph shows the conduit being installed along Fourth Avenue. We're looking north into the Park Avenue Tunnel.

Manhattan's electric conduit was sturdy, heavily built, compared to the one in Budapest: heavy slot rail, yoke, and concrete foundations (Figure 4). After excavation, iron yokes, steel rails, and other iron pieces, were put in place and bolted together. Then the two tracks were lined up, leveled, and temporarily supported, while concrete was rammed underneath and around the yoke supporting them. The primary reason why the iron structure was so heavily built, was prevent the slot from closing up due to expansion of the pavement and granite blocks laid in the streets.

The conduit was a thirteen-inch diameter hollow tube made of cement. It sat just beneath the slot formed by the two middle rails. After the cement had dried, the hollow tube was ready for the two iron rails - the electric conducting bars. During that time, terra cotta ducts were installed, allowing the road to be repaved. Once the street was clear for traffic, electrical work could begin: two conductor rails were inserted into the tube, insulators were attached to posts housed in manholes, and lastly, electric wires were pulled and terminated.

It should be mentioned that the major disadvantage of the electric conduit was its high construction cost. The work was expensive because many obstructions were encountered beneath the streets where

gas, water or sewer pipes had to be relocated. Another major cost item had to do with special tracks required at intersections. There were many intersections in Manhattan where one streetcar line intersected with another line. Each intersection required special tracks with complex manually operated switches to allow cars to cross over another line. The most exciting intersections were the ones where cable cars had to cross over the electric conduits, and vice versa! I can't explain their switching procedure, but presumably car momentum was an essential step.

The power system that moved Manhattan

The next paragraphs will highlight the electric power system that ran all streetcars on Manhattan, with some exceptions: horse lines still persisted in the downtown area, in addition, the Third Avenue Railway Company operated its own power station (Kingsbridge) independently, until it was taken over by Metropolitan. Discussion will focus on the final state of their electrical power system. Temporary 600 volt dc stations, interim circuit arrangements, switchovers, to accommodate sequencing of work are beyond the scope of this paper. Instead we will focus on the final configuration (Figure 5).

The electrical power system consisted of:

- A very large central generating station on 96th Street
- 6600 volt, three-phase, 25 cycles, alternating current
- Vertical cross-compound Corliss steam engines
- General Electric's largest available generators
- Seven substations with the latest rotary converters Extensive ac and dc underground distribution

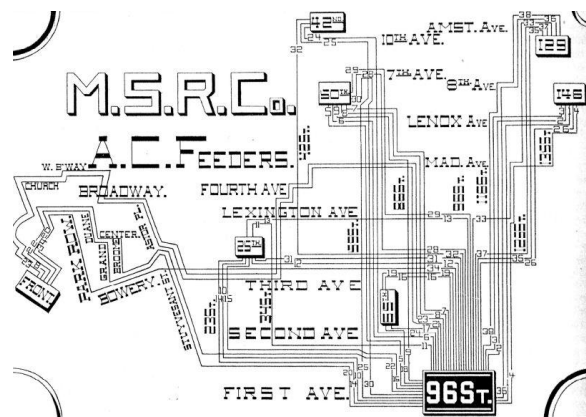

Figure 5 -The power system that moved Manhattan.

96th Street power station

The Metropolitan Street Railway announced its plan to build a very large central power generating station on 96th Street on the East River. This station was going to be the first of the several large poly-phase generating station operated in New York City. The East River would provide access to coal and cooling water. The design of the station was going to include the latest technological innovations: high voltage class, largest Corliss compound steam engines, direct-driven generators, and remote controlled circuit breakers with air cylinders. In addition, fireproofing, redundancy and segregation of apparatus, were going to be incorporated in the layout of the station.

The 96th Street power station was the first of five large reciprocating steam engine generating station built in New York City. 96th Street began construction in 1898 and was placed in service sometimes in 1899, up to two years before some of the better-known power stations. These others were, in the order placed in service: Kingsbridge (Third Avenue Railway Company, January 1900); Waterside (Edison enterprise, 1902); 74th Street (Manhattan Railway Company's elevated road, 1902), and 59th Street (IRT - Interborough Rapid Transit for subways, 1902).

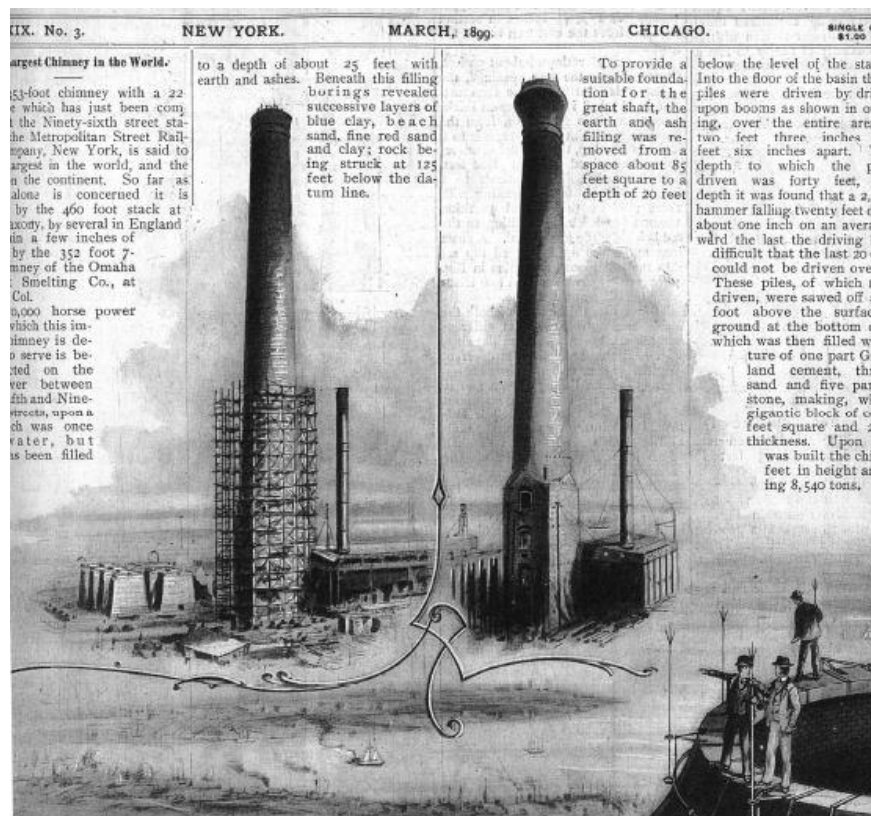

Figure 6 – 96th Street power station's great chimney was 353 feet high, just a few inches taller than the tallest stack on the continent located at a smelter plant in Colorado. (Power, March 1899)

The 96th Street power station was well documented by articles accompanied by drawings and photographs. Many of these articles had similar text and identical images, suggesting the work of a company publicity department. These articles appeared in Scientific American magazine, Electrical World, Engineering News Record, Power, Street Railway Journal and in English journals. In 1899, Power magazine wrote about the amazing huge chimney being built on the East River (Figure 6).

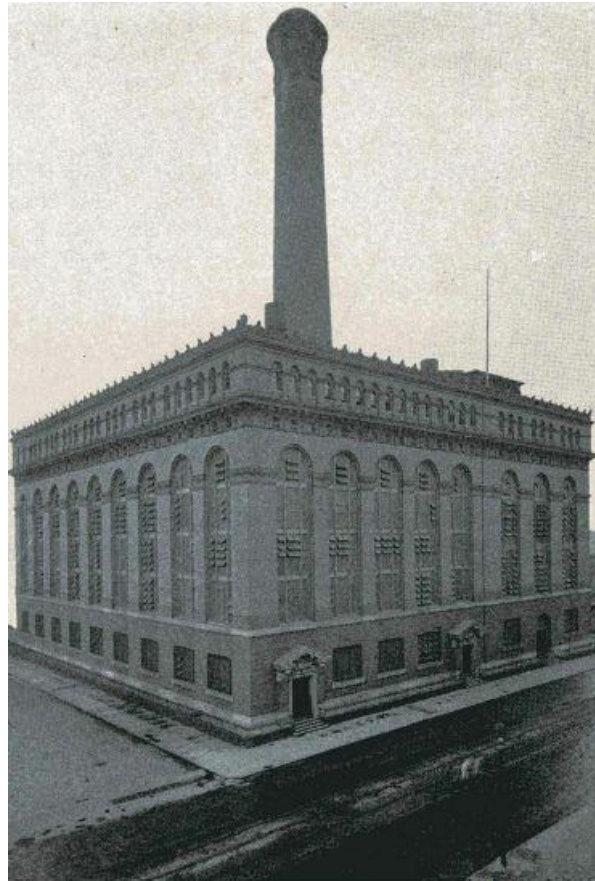

Figure 7 - A rare photograph of 96th Street power station built in the late 1890s. Its unique feature was the single stack: two or four stacks was a more common design.

The building (Figure 7) was rather plain looking, without a façade, made of yellow brick with steel trusses and framing. All floors were made of terra cotta arches supported on I beams with concrete filling. Building designers paid special attention to fire proofing, ventilation and lighting. Steam at a pressure of 160 pounds per square inch was supplied by eighty Babcock and Wilcox boilers arranged on three floors of the boiler house. The station had large steam engines, the largest at the time, manufactured by Allis Chalmers, exhausting into surface condensers. The steam cycle did not include economizers. All station auxiliaries were steam driven, standard design for a traction power plant at the time. The chimney provided natural draft. Coal was the fuel of choice.

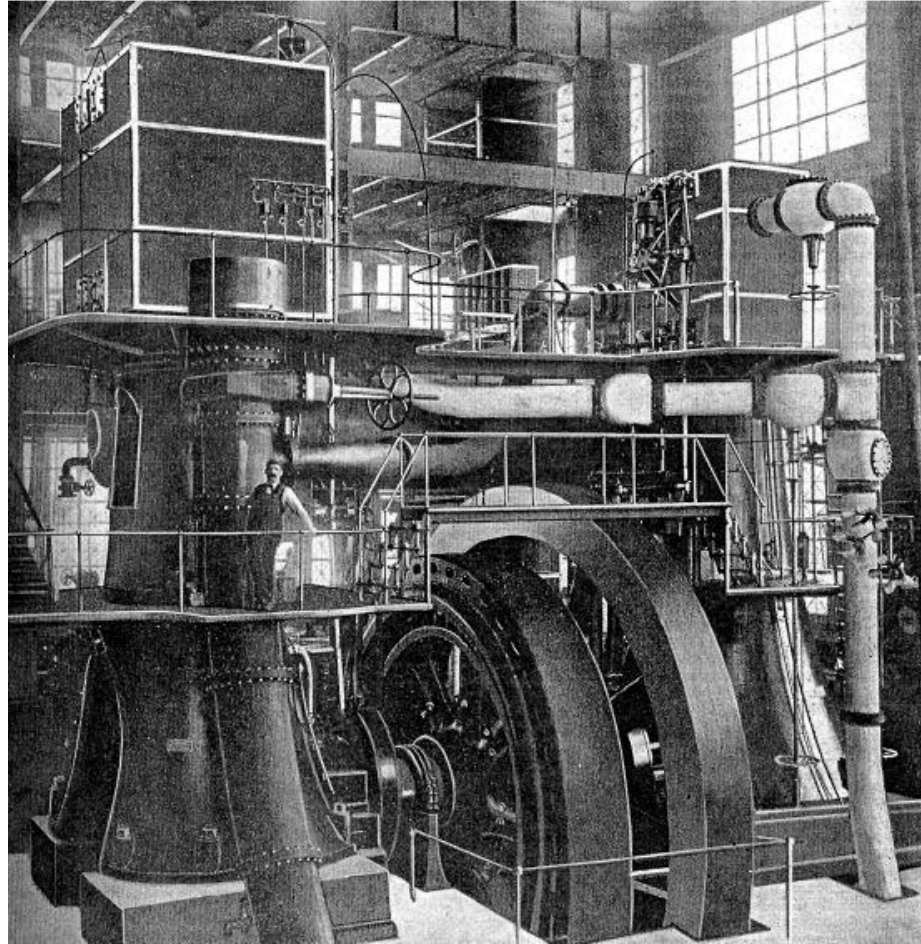

Figure 8 -One of eleven Corliss reciprocating steam engine, which at the time was the BEST AVAILABLE TECHNOLOGY. Tall, quiet, graceful looking machines, turning steadily at 75 rpm. The engine was capable of operating on one steam cylinder. Note that the main steam, normally piped to the high-pressure cylinder (right), can be diverted to flow directly into the low-pressure cylinder (left).

Inside the station, there were eleven reciprocating steam engines (Figure 8), arranged in two rows face to face. These machines were the first, and at the time, the largest, vertical cross-compound Corliss steam engines ever manufactured. Small by today's standards, each generator was directly coupled and had an output rating of 3500 kilowatts, three-phase, 6600 volts, at 25 cycles. Harris J. Ryan, a prominent figure in electrical engineering, and a celebrated member of the AIEE, was familiar with the work going on in New York, and knew about the design and fabrication of these generators. Ryan was probably hired as consultant to provide independent inspections at the factory in Schenectady. In any case, he wrote an article about it and had this to say about the generators: "These are the first generators of their size in the world to be steam driven. It is not, so much in their great size that their chief interests lies. They are the pioneers of a type of electrical generator that characterizes the most modern and probably most permanent electrical engineering practice."

Distribution of alternating current

6600-volt three-phase feeders for Manhattan's surface transit lines are illustrated in Figure 5. This diagram clearly shows an elaborate electrical network covering a wide geographic area. It's important to mention that the power supply for the transit system was essentially completed all at once, instead of being grown circuit by circuit to accommodate increasing loads. From the central generating station on 96th Street, power feeders were routed underground to seven rotary substations strategically located around the city. Redundant feeders were kept segregated from one another by routing each cable on a different street. Arranging circuits like this, has been standard practice among power utilities for a long time, but this project is believed to have been the first. Power cables were three 4/0 conductors. Because of limited experience with high voltage cable insulation, two different types of cables were specified and installed: paper insulated conductors with lead jacket, and rubber insulated cable. Cables were evaluated and the information shared with the power industry through published articles. Eventually, the company settled on paper-insulated cable as standard.

Because of the complexity and size of their vast underground distribution, company engineers came up with a method for documenting the location of each conduit and each cable. Although this is standard practice among today's utilities, Metropolitan engineers may have been the first to develop such a scheme.

DC traction

Metropolitan's traction power will be briefly described next. There were seven traction substations with a total of twenty-seven rotary converters manufactured by General Electric Company. Each substation housed standard equipment, transformers, switchboards, batteries and three or more rotary converters ranging in size from 900 to 1000 kilowatts. 600 volt cables, taps, connections, jumpers, were located in manholes along the tracks beneath the streets (Figure 9). Telephones were installed in major manholes for electricians to communicate with substation operators.

These telephones may have been used to help them troubleshoot and isolate grounds on dc buses.

Grounding was a major concern because electric conductor bars were exposed to weather and other tough conditions. So the project had to devise an ingenious way to maintain cars running while the system was partially grounded. This was accomplished by a unique double-throw switching procedure whereby the polarity of any one conductor bar could be changed from, say, a positive bar to a negative bar. This was done by having each positive and negative feeder connected to a double-throw switch, one terminal of each switch being connected with the positive switchboard bus and the other with the negative switchboard bus. The substation operator could simple transfer one section of conductor bars and reverse their polarities. By switching polarities, it became possible to operate the system longer in the presence of dispersed grounds until cleared by maintenance personnel.

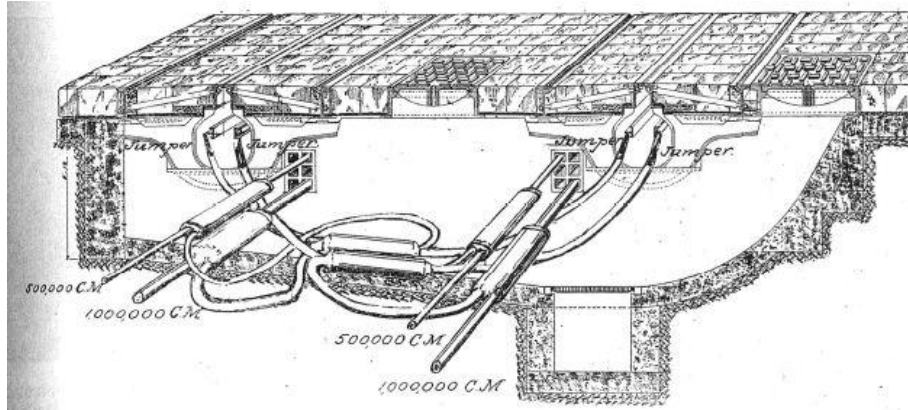

Figure 9 - Diagram shows how underground components were installed in a typical manhole.

The plow

Critical components of the conduit system resided below grade (Figure 9). The plow (Figure 10) was suspended from the street vehicle, passing through a narrow slot between the tracks. There were two iron conductor bars, one at 300 volt positive dc, and the other at 300 volt negative dc. When the plow was fully inserted in the conduit, it pressed against the conductor bars by spring-loaded cast iron shoes. Shoes lasted approximately ten days.

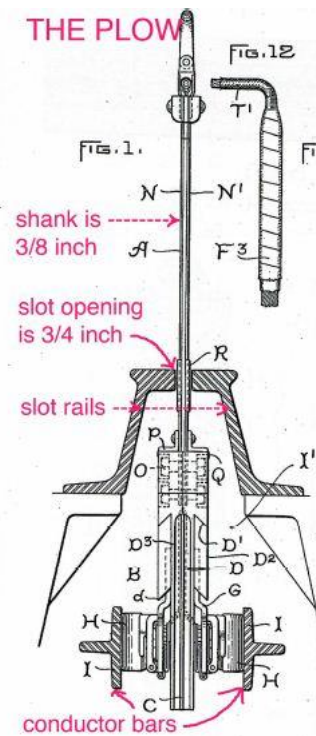

Figure 10 - The soul of the machine is the plow, US Patent 639,235, Hewlett 1899.

The plow was fabricated from two sheets of steel sandwiching a slender piece of insulating material. The shank, the long slender part was only 3/8 inch thick. The plow was attached to each vehicle by workers standing in a car pit as the vehicle exited the car house. The slot opening in the street was only 3/4 inch wide. With the shank only 3/8 inch thick, this left a clearance of 3/16 inch on each side. Maintaining this clearance was critical; otherwise the plow could jam and tear away from the car.

I believe that the electric conduit could have passed today's ball-bearing test. The ball-bearing test is the one shown on television advertising the quality virtues of a foreign car. Manhattan's conduit was equally engineered. It was a large electromechanical machine, 300 miles long, built with many precision parts. This machine was designed to survive very harsh operating conditions on city streets. Nothing was left to chance because streetcars were required 24/7. Maintainability issues were addressed during the design phase, for example, by providing openings in the streets and cleaning apparatus for keeping conduits clean.



Figure 11 –Here's a plow that survived. Thanks to Robert Lobenstein and Charles Sachs for this photograph from their collection at the New York Transit Museum.

Final cutover to electricity

Following the successful Lenox Avenue trials, electrification of the entire transit system began in earnest. The electric conduit then had become Metropolitan's primary mode of transportation, except for three remaining cable lines that had kept the company in business since 1894: Broadway, Columbus

and Lexington Avenues. These remaining lines were finally converted to electricity in dramatic fashion in 1900.

Amazingly, this final phase was accomplished with little or no interruption in passenger service. After months of planning, practicing, and preparations, each line was shut down for just twenty (20) hours to complete a series of delicate tasks inside the hollow tube. This work was accomplished with great technical skills and with military precision to prevent all possibility of errors in substituting one mode of traction for the other. Thousands of men worked through the weekend. Their final task was cutting the steel ropes loose, coiling them back into the cable house, and turning the electricity on. A grand finale for the completion of a fantastic project. At its conclusion, the New York Times had this to say: "So much has never been accomplished in so short a time, in this or any other city".



Figure 12 – Streetcars traveling on Broadway at Union Square in 1904 were propelled by electricity from the slot in the road. Courtesy of A.Lonto.



Figure 13 - An open car and a semi-enclosed vehicle wait at Park Rowe before takeoff in 1898. Each car carried 60 passengers. Courtesy of the Schenectady Museum, General Electric Collection.

Accomplishments

The electric conduit system remained in service until the nineteen thirties. Although the founding company went into receivership in 1904, taking on different corporate names, such as, New York City Railway Company, the Green Line, that does not diminish its many accomplishments. The conduit project may well have been the most important and extensive engineering work in this country over 100 years ago. As a result, 8000 new 'high technology' jobs were created. The enterprise ended up operating 3280 electric cars on 300 miles of tracks. At its peak, Metropolitan operated forty-seven transit lines. In spite of its success in displacing thousands and thousands of horses, it was unable to completely eliminate horse- cars within its territory.

The company spent a lot of time and money looking for a substitute for horse-drawn cars on cross-town traffic, traveling short distances, east and west. A large 2400 pounds per square inch air compressor plant was built having a capacity for 80 cars. Compressed air was stored in metal cylinders housed under the passenger seats.

Commercial service extended over nearly two years but after frequent failures, accidents, and public dissatisfaction, air car service was withdrawn and the horses reintroduced.

In August 1900, a large battery storage station with a capacity of fifty cars was established. The line was operated by the storage battery cars until September 1903. Unfortunately, this technology also failed. Battery cars were removed from service because of frequent breakdowns and passenger discomfort caused by fuming of the batteries. A cable line was constructed instead.

In closing

It was Metropolitan Street Railway Company that first introduced safe and comfortable transportation for travelers in Manhattan. This service was rendered on surface roads using the electric conduit, a service which continued while the subway and elevated lines were being developed. Metropolitan was the first to run a dependable mass transit system and promote travel by free interchange of transfers. It also manned special streetcars waiting on sidetracks to serve the crowds leaving Manhattan's theater district. The electric conduit remained in service for nearly 40 years. By 1936, buses had replaced the last electric trolley car. Years later, car tracks were removed and the streets were repaved.

At this time I'd like to acknowledge the New York Transit Museum. This museum is the right institution to preserve the history of New York's electric conduit. I wish them well in their efforts to increase their collection of artifacts and photographs.

96th Street power station no longer exists because it was demolished long ago. But if you walk along the East River to 96th Street, you can see where the power plant once stood (Figure 14).



Figure 14 - Site of the 96th Street Power Station on the East River in New York. Photo by R. Lobenstein, 2007.

This paper is based on the following references:

- "The Metropolitan Street Railway System", New York Electric Handbook, American Institute of Electrical Engineers, 1904. pp. 125-167.
- F.S. Pearson, "The Latest Developments in Electric Conduit Railways," Cassier's Magazine, August 1899, pp. 257-282.
- Harris J. Ryan, "The Three Phase Alternator of the Metropolitan Street Railway Company of New York City," The Sibley Journal of Engineering (Cornell), February 1901, pp. 175-187.

- L.G. Montony, “The 96th Street Power Station of the Metropolitan Street Railway Company of New York City,” Transaction ASCE No 881, December 1900, pp. 119-148.
- Walter A. Pearson, “The Electrical Distribution System of the Metropolitan Street Railway Company, New York,” October 5, 1901, pp. 958-965.
- New York Times (1894-1904) digital collection, available online through major public libraries.

For further reading

- Alan Paul Kahn, *The Tracks of New York, Metropolitan Street Railway 1907*, Electric Railroaders Associations Inc., New York City, 1973.
- Stephen L. Meyers, *Images of Rail, Manhattan’s Lost Streetcars*, Arcadia Publishing, 2005.
- “The Mammoth Central Power Station of the Metropolitan Street Railway Company, New York,” *Scientific American*, Nov 12, 1898, pp. 307-308.
- “A 70,000 Horse Power Central Station,” *Scientific American*, January 13, 1900, p. 26.
- “Reconstruction of New York Street Railway,” *Scientific American*, March 31, 1900, p.258.
- “A New 70,000 H.P. Central Power Station of the Metropolitan Street Railway Company, NY,” *The Electrical Engineer*, October 7, 1897, pp. 317-319.
- “New York’s New Chimney,” *The Engineering Record*, December 17, 1898, pp. 53-54.
- “Construction of a Large Power House Building,” *The Engineering Record*, December 23, 1899, pp. 690-696.
- “Foundations and Chimney for 45,000 HP Electric Power Station, Metropolitan Street Railway Company, New York City,” *The Engineering News*, December 23, 1899, pp. 140-143.
- “New Power Station for the Metropolitan Street Railway Company,” *The Engineering Record*, July 28, 1900, pp. 79-80.
- J.E. Woodbridge, “The Polyphase Distributing System of the Metropolitan Street Railway of New York City Part 1,” *Electrical World and Engineer*, March 31, 1900, pp. 693-698.
- J.E. Woodbridge, “The Polyphase Distributing System of the Metropolitan Street Railway of New York City Part 2,” *Electrical World and Engineer*, April 7, 1900, pp. 501-504.
- Charles A. Hague, “The Steam Engine for the Electric Traction Power House,” *The Engineering Magazine (NY)*, October 1899 to March 1900, pp. 425-430 & 558-571.
- “The Largest Steam Plant in the World – Proposed Power Station of the Metropolitan Street Railway Company, New York,” *Power*, December 1897.

Also on "Street Railway Journal" from 1895 to 1901, notably:

- "Main Power Station and Transmission System of the Metropolitan Street Railway Company of New York," March 3, 1900, pp. 213-226.
- "Changing the Broadway Road from Cable to Electric Power," September 1, 1900, pp. 830-831.
- "The Removal of Cable Traction from New York," June 8, 1901, pp. 681-683.
- H.H. Vreeland, "The Up Building of the Metropolitan Organization," October 5, 1901, pp. 397-401.
- M.G. Starrett, "Notes on the Metropolitan Street Railway Power Plants," October 5, 1901, pp. 407-413.



- H.H. Vreeland, "Cars and Car Service in Metropolitan New York," October 13, 1901, pp. 958-965.

*** Gilmore Cooke, IEEE LSM, is the chair of Milestone and History Committee, Boston Section**

Tidbits

Amitava Dutta-Roy

I wonder if you are following the IPO of Facebook (aka fb by the aficionados). I do not use fb. I have no use for such social networks that supposedly let you share photos and other stuff. However, if you happen to be trigger happy (on your digital camera, obviously) you may soon run out of a convenient space to store them. It also becomes pretty difficult to share the documents or photos. Since we are still in the 17th place in the world in bandwidth speed, any transfer of items that are over a few megabytes in size may be frowned upon by recipients and not all senders know how to compress a photo file.

A couple of years ago my 35mm film processing facility shut down and the long-time customers were given a free access to Shutterfly, the company that stores digital photos. I found Shutterfly rather cumbersome. Uploads took long times. Then last year at the Web 2.0 expo in New York I discovered Skydrive, a parking and sharing place in the cloud offered and administered by Microsoft. To use the facilities of Skydrive.com you need just an address at .hotmail.com or .livemail.com. I found Skydrive is easy to use. Both uploads and downloads are fast enough to my liking. It is also possible to share your files or photos. There are three options for sharing.

- The remote viewer can only see the files or photos through a secure (https) connection. All you have to do is to get a link that readily comes up in a “Get a link” window. You copy the URL and send it to your friends. Only those who have the URL can see the files.
- The viewer can not only see but is allowed to edit the contents. If you check the little box for this option you get a separate link.
- Anybody in this wide world can search and view your files.

The following screen shots will visually explain how to use Skydrive.

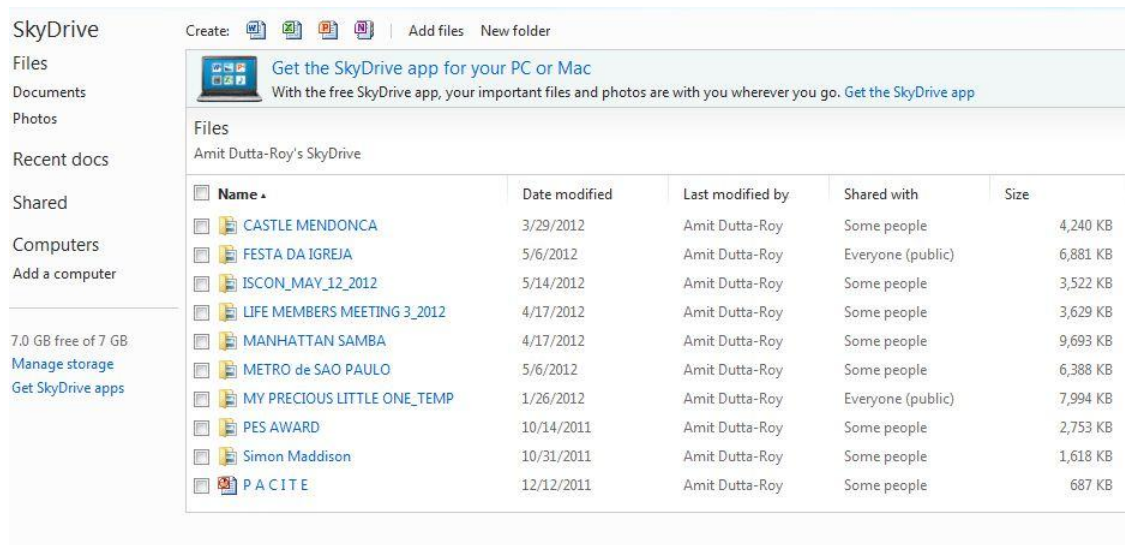

The screenshot shows the SkyDrive web interface. On the left is a navigation sidebar with options like Files, Documents, Photos, Recent docs, Shared, Computers, and Add a computer. The main area displays a list of files under the heading 'Amit Dutta-Roy's SkyDrive'. The list includes columns for Name, Date modified, Last modified by, Shared with, and Size. A banner at the top encourages downloading the SkyDrive app for PC or Mac.

Name	Date modified	Last modified by	Shared with	Size
CASTLE MENDONCA	3/29/2012	Amit Dutta-Roy	Some people	4,240 KB
FESTA DA IGREJA	5/6/2012	Amit Dutta-Roy	Everyone (public)	6,881 KB
ISCON_MAY_12_2012	5/14/2012	Amit Dutta-Roy	Some people	3,522 KB
LIFE MEMBERS MEETING 3_2012	4/17/2012	Amit Dutta-Roy	Some people	3,629 KB
MANHATTAN SAMBA	4/17/2012	Amit Dutta-Roy	Some people	9,693 KB
METRO de SAO PAULO	5/6/2012	Amit Dutta-Roy	Some people	6,388 KB
MY PRECIOUS LITTLE ONE_TEMP	1/26/2012	Amit Dutta-Roy	Everyone (public)	7,994 KB
PES AWARD	10/14/2011	Amit Dutta-Roy	Some people	2,753 KB
Simon Maddison	10/31/2011	Amit Dutta-Roy	Some people	1,618 KB
P A C I T E	12/12/2011	Amit Dutta-Roy	Some people	687 KB

This is a view of the list of my files that I have parked in Skydrive.com

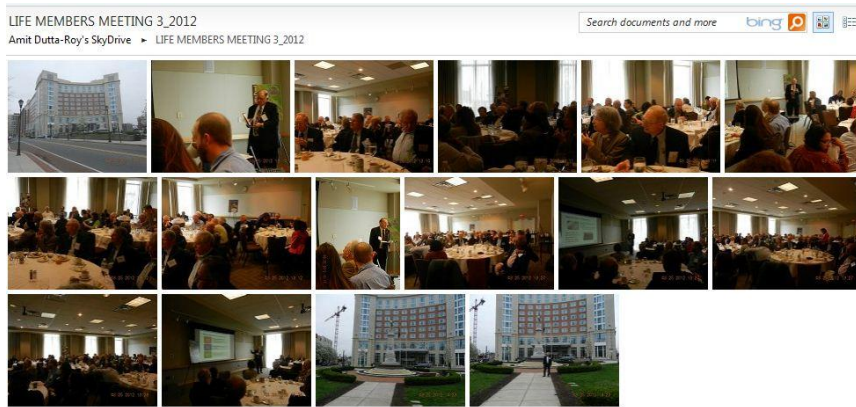

This is screen shot displaying the Life Members' meeting at New Brunswick on March 25, 2012

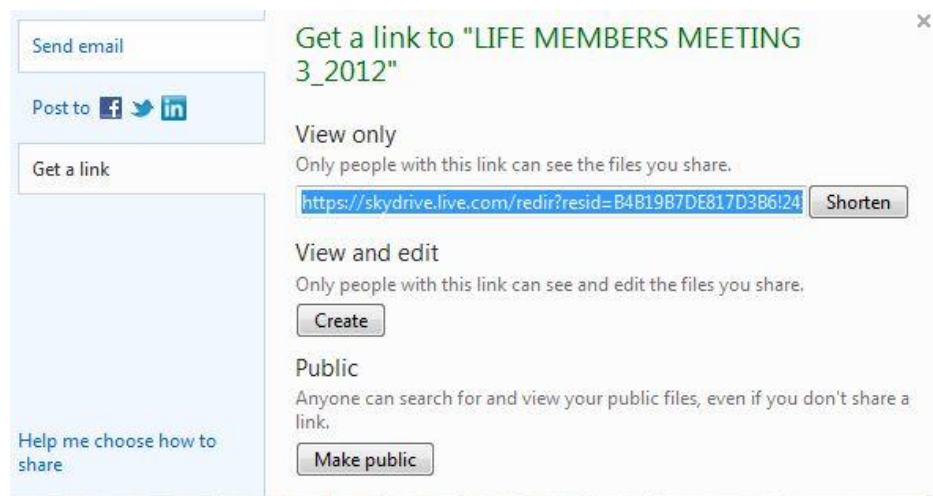

You have a choice in the manner of sharing your files

I was able to talk at length with a product manager at Microsoft HQ. I was informed that currently there is no limit to the space a user is allowed. He said that the software will continuously check if I do use it regularly. If you do so, it will automatically increase the space allotted to you. Hope this helps you park your valuable photos in a safe place and share them with friends.

This is the end of the May 2012 edition of the Monitor.

Thank you for your visit.